

Un raffinato progetto haute-couture caratterizzato da dettagli eleganti che richiamano l'alta sartoria. Particolare attenzione è stata dedicata alle cuciture intorno allo schienale/bracciolo per creare una raffinata pince, da cui parte una cerniera fino alla base del divano, proprio come un abito. Il suo aspetto è ulteriormente arricchito da un profilo in gros-grain intorno ai cuscini della seduta, disponibile in nero, bianco, grigio e caffelatte. Dress-Up! ha un'ampia scelta di elementi da combinare in numerose composizioni o utilizzare individualmente. Le sue linee geometriche e gli elementi asimmetrici, come la chaise-longue integrata, lo rendono unico e versatile mentre lo schienale/bracciolo a inclinazione aperta enfatizza la sua forma accogliente. I pouf combinati, disponibili in due misure, hanno lo stesso dettaglio in gros-grain oltre a una zip verticale lungo il lato. Per completare questa famiglia di prodotti per l'area living, il divano può essere accompagnato da una serie di tavolini e da raffinati cuscini sempre con il profilo gros-grain.

Gallery

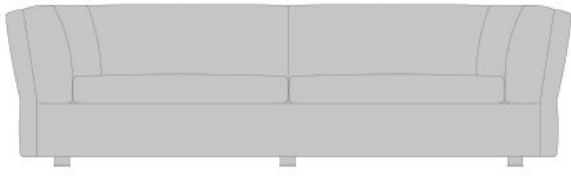



67 cm
26.4 "



40 cm
15.7 "

230 cm
90.6 "

98 cm
38.6 "

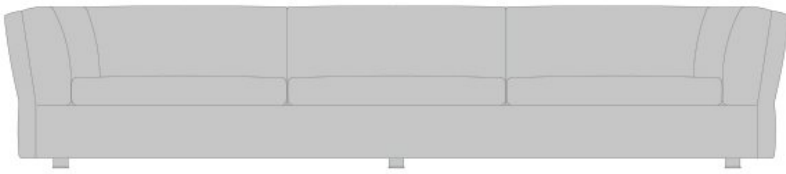

67 cm
26.4 "

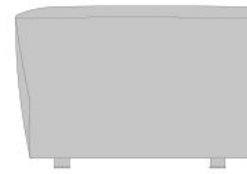

40 cm
15.7 "

320 cm
126.0 "

98 cm
38.6 "

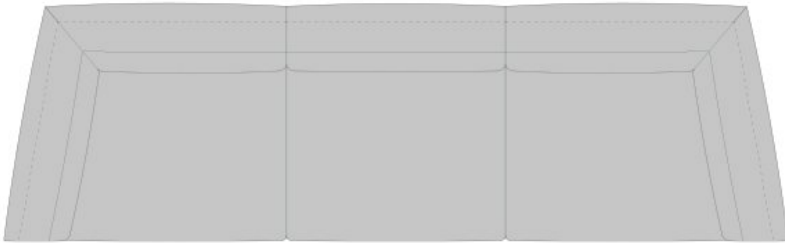

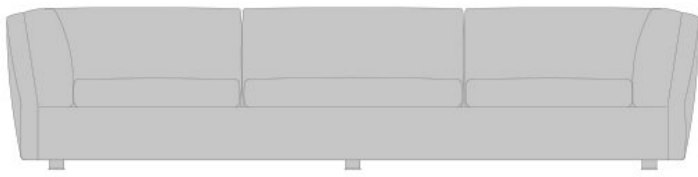

290 cm
114.2 "



67 cm
26.4 "

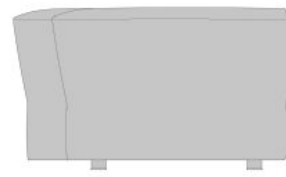

116 cm
45.7 "



40 cm
15.7 "

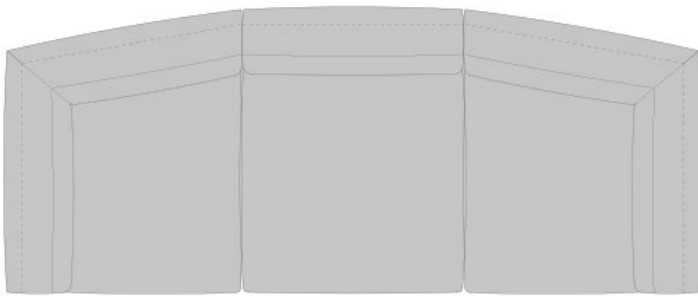

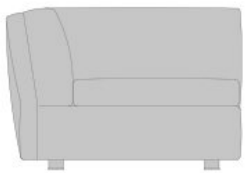

98 cm
38.6 "

67 cm
26.4 "

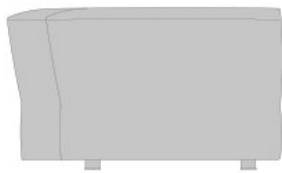

116 cm
45.7 "

40 cm
15.7 "

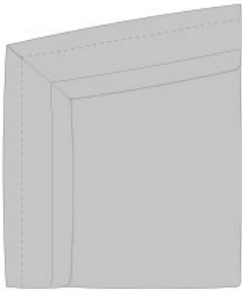

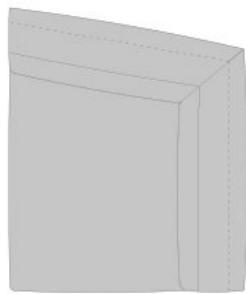
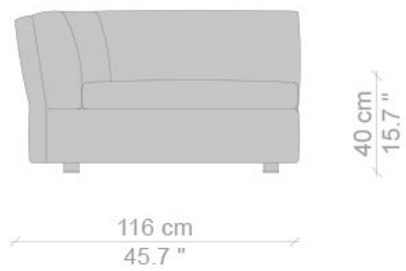
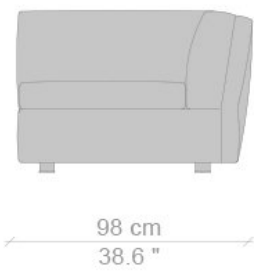

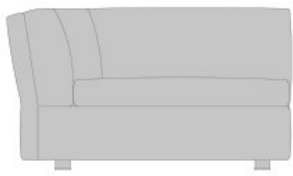

67 cm
26.4 "

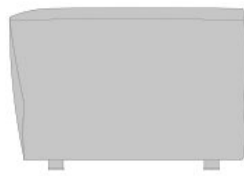

40 cm
15.7 "

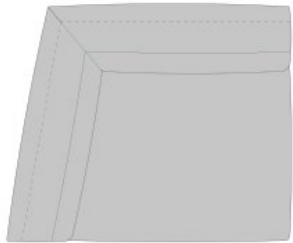

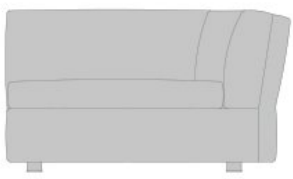

116 cm
45.7 "

67 cm
26.4 "



98 cm
38.6 "

40 cm
15.7 "

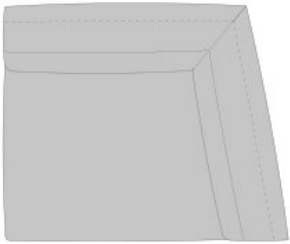



184 cm
72.4 "



98 cm
38.6 "



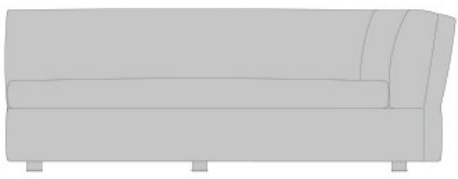

184 cm
72.4 "



98 cm
38.6 "



40 cm
15.7 "





178 cm
70.1 "



67 cm
26.4 "



98 cm
38.6 "



40 cm
15.7 "



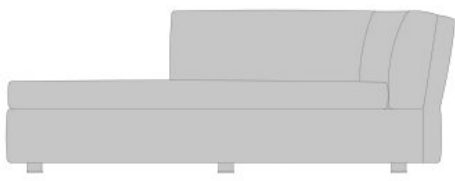

178 cm
70.1 "



67 cm
26.4 "

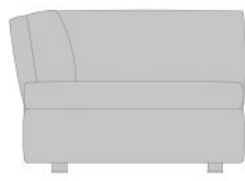

98 cm
38.6 "



40 cm
15.7 "

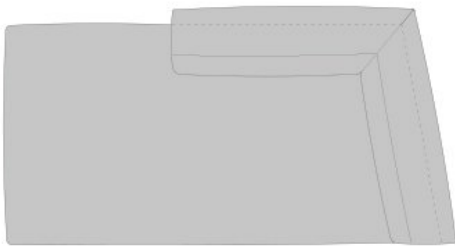

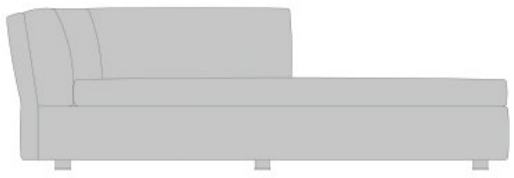

206 cm
81.1 "

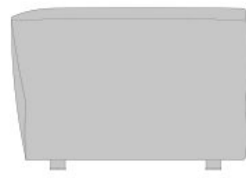

98 cm
38.6 "

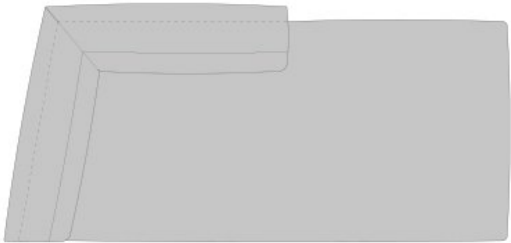

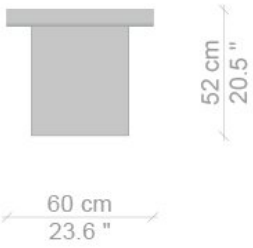
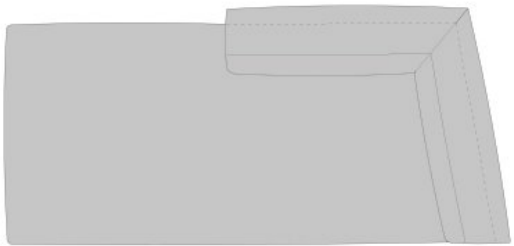
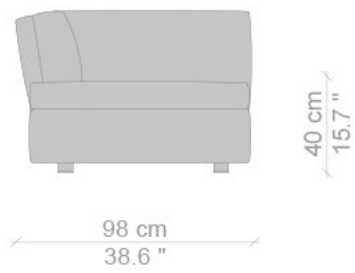
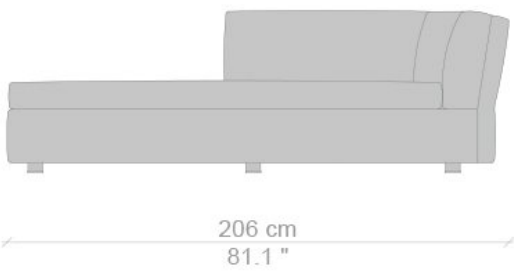

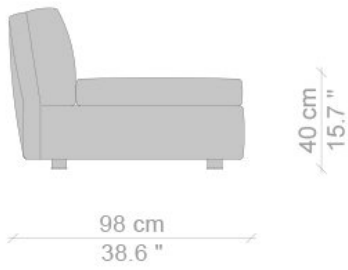
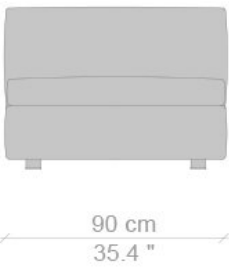
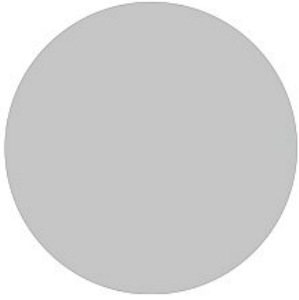
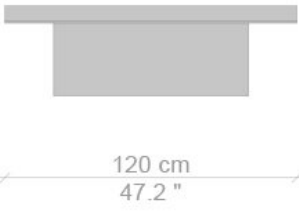



90 cm
35.4 "

67 cm
26.4 "



116 cm
45.7 "

40 cm
15.7 "

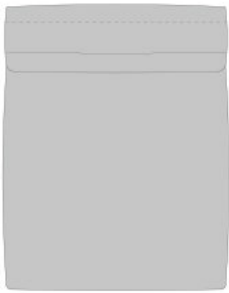



90 cm
35.4 "



67 cm
26.4 "

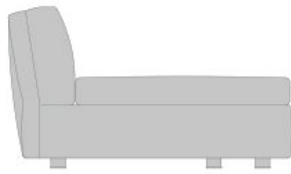

116 cm
45.7 "



40 cm
15.7 "

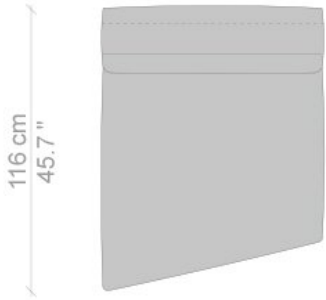

116 cm
45.7 "



90 cm
35.4 "



90 cm
35.4 "

67 cm
26.4 "

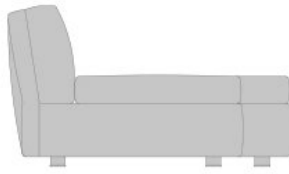

116 cm
45.7 "

40 cm
15.7 "

90 cm
35.4 "



116 cm
45.7 "



67 cm
26.4 "

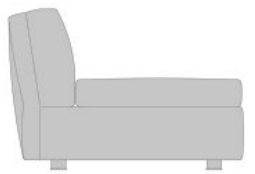

40 cm
15.7 "

158 cm
62.2 "

98 cm
38.6 "

90 cm
35.4 "

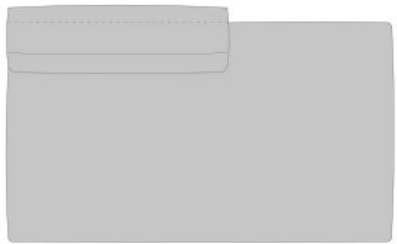

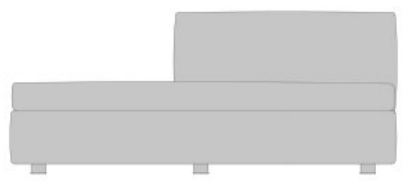

158 cm
62.2 "



67 cm
26.4 "

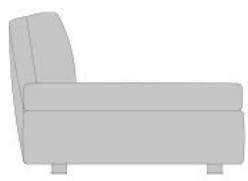

98 cm
38.6 "



40 cm
15.7 "



90 cm
35.4 "

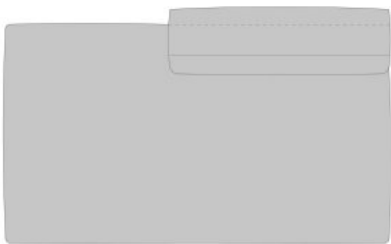

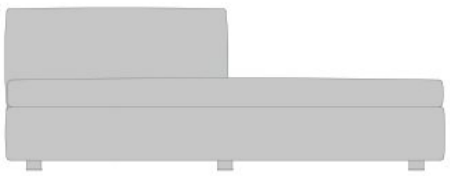

180 cm
70.9 "

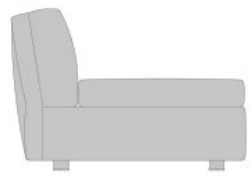

40 cm
15.7 "

98 cm
38.6 "

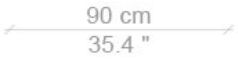

90 cm
35.4 "

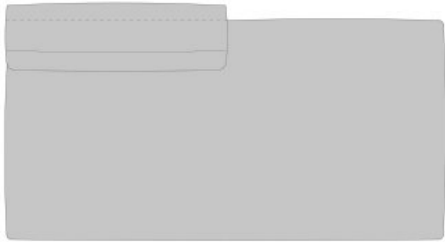

90 cm
35.4 "



180 cm
70.9 "



67 cm
26.4 "

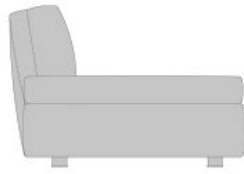

98 cm
38.6 "



40 cm
15.7 "



90 cm
35.4 "

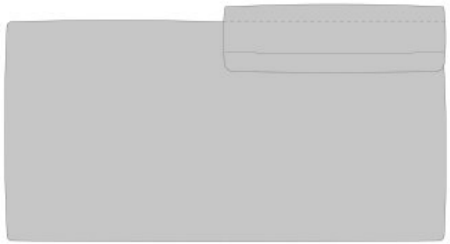

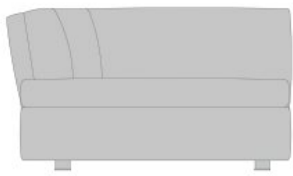

116 cm
45.7 "

67 cm
26.4 "

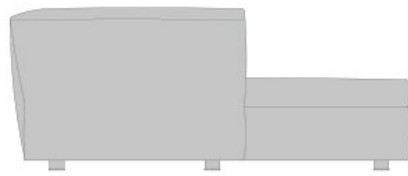

165 cm
65.0 "

40 cm
15.7 "

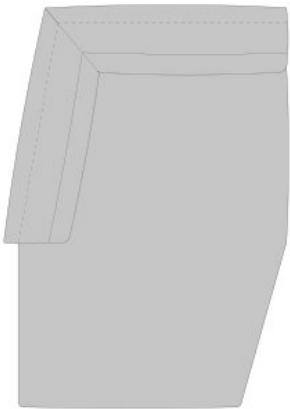

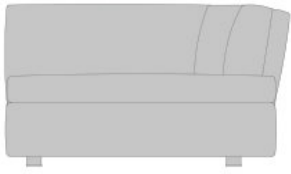

116 cm
45.7 "



67 cm
26.4 "



165 cm
65.0 "



40 cm
15.7 "

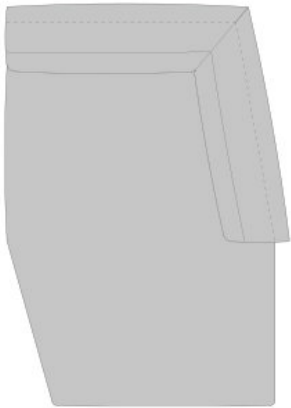

40 cm
15.7 "



45 cm
17.7 "



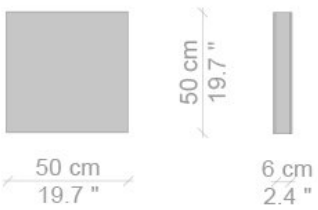
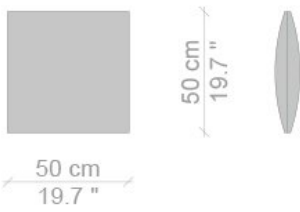
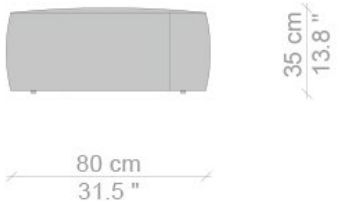

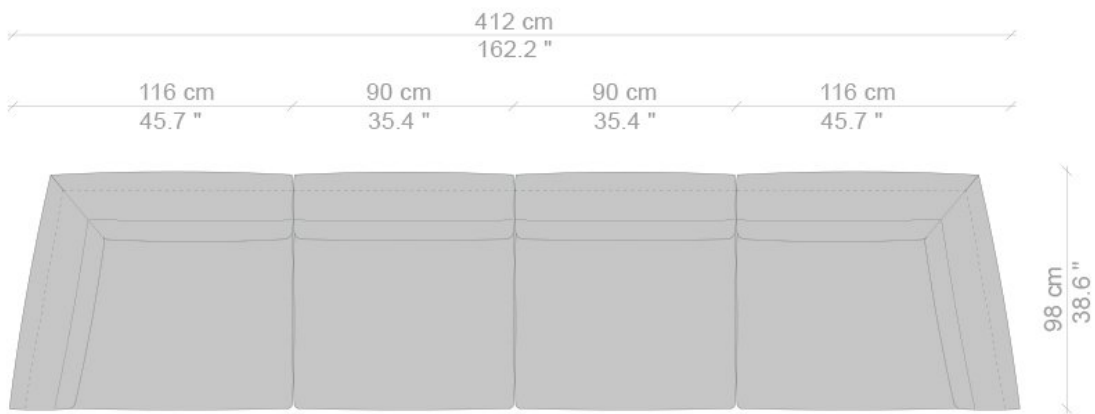
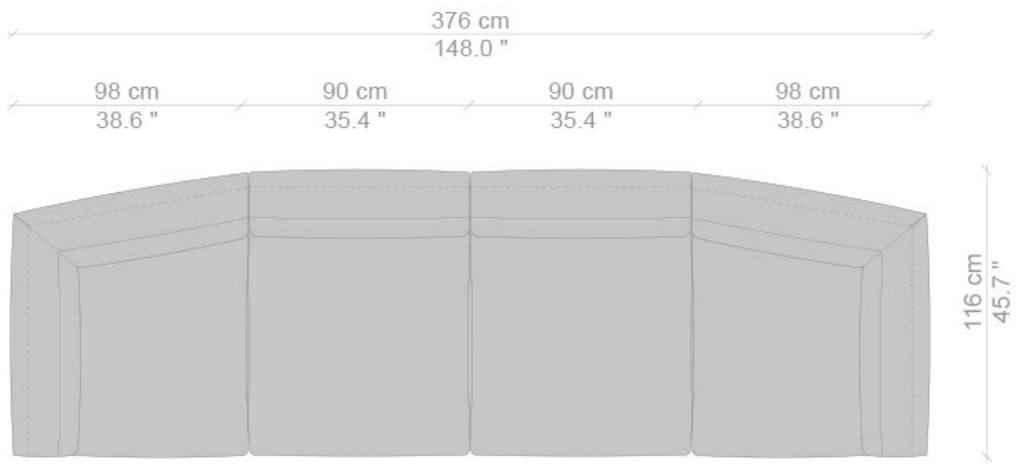

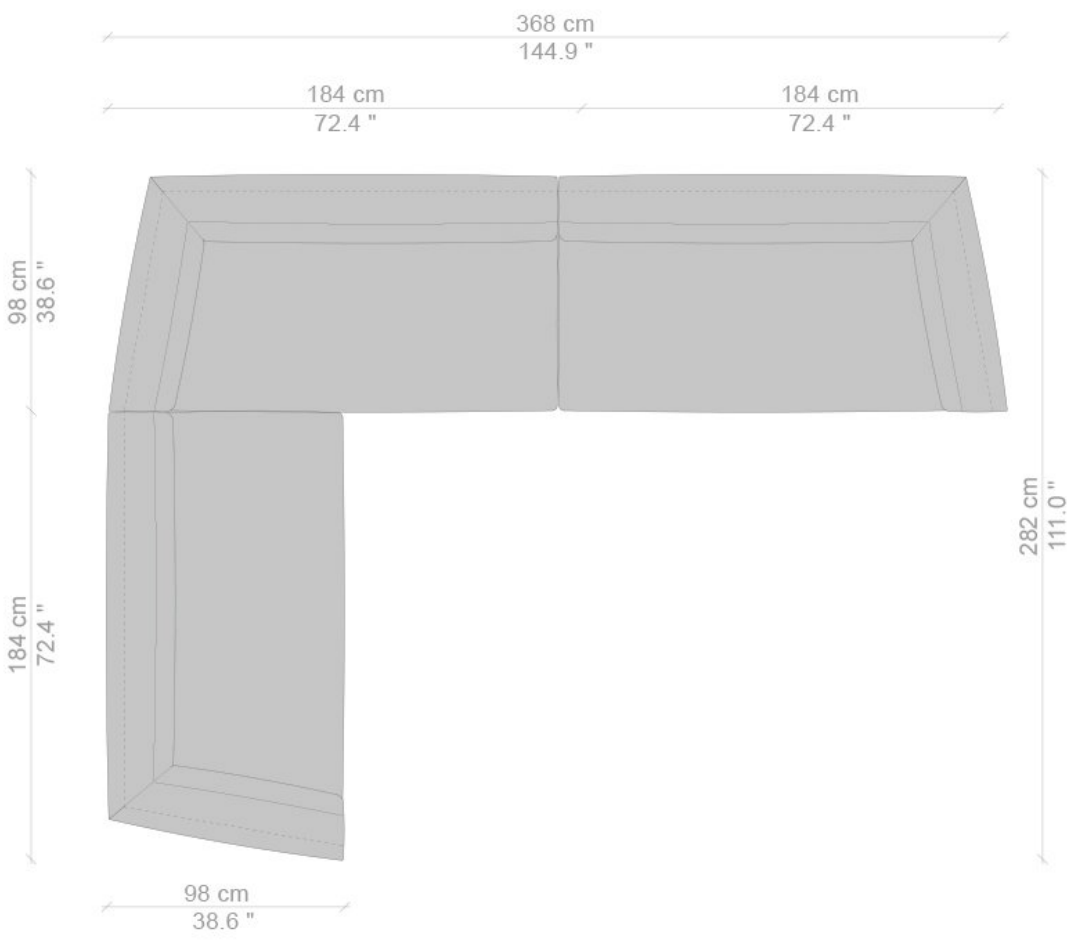
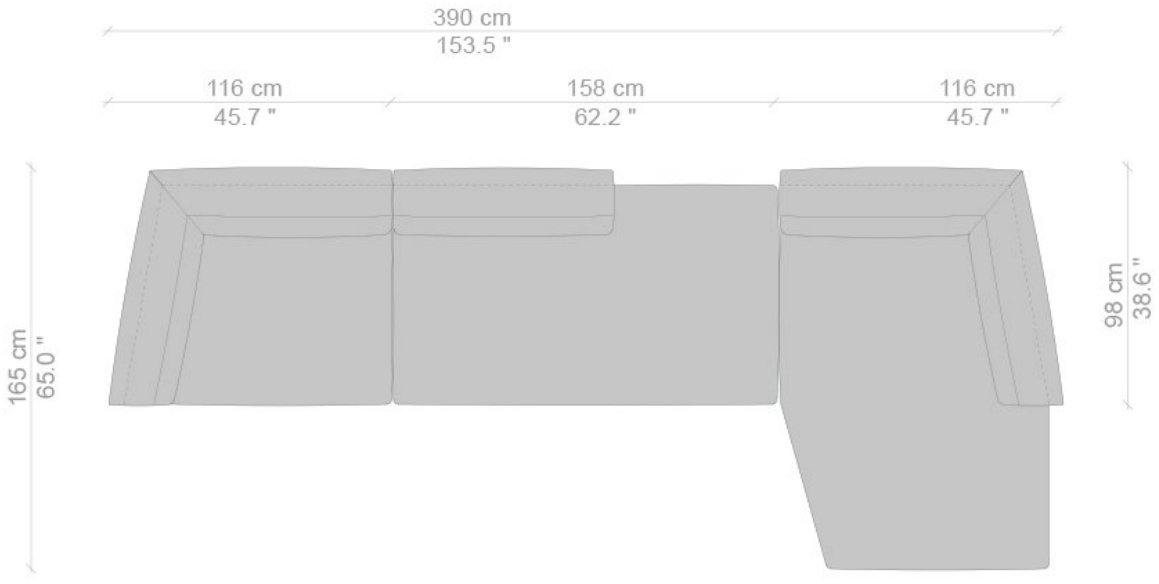

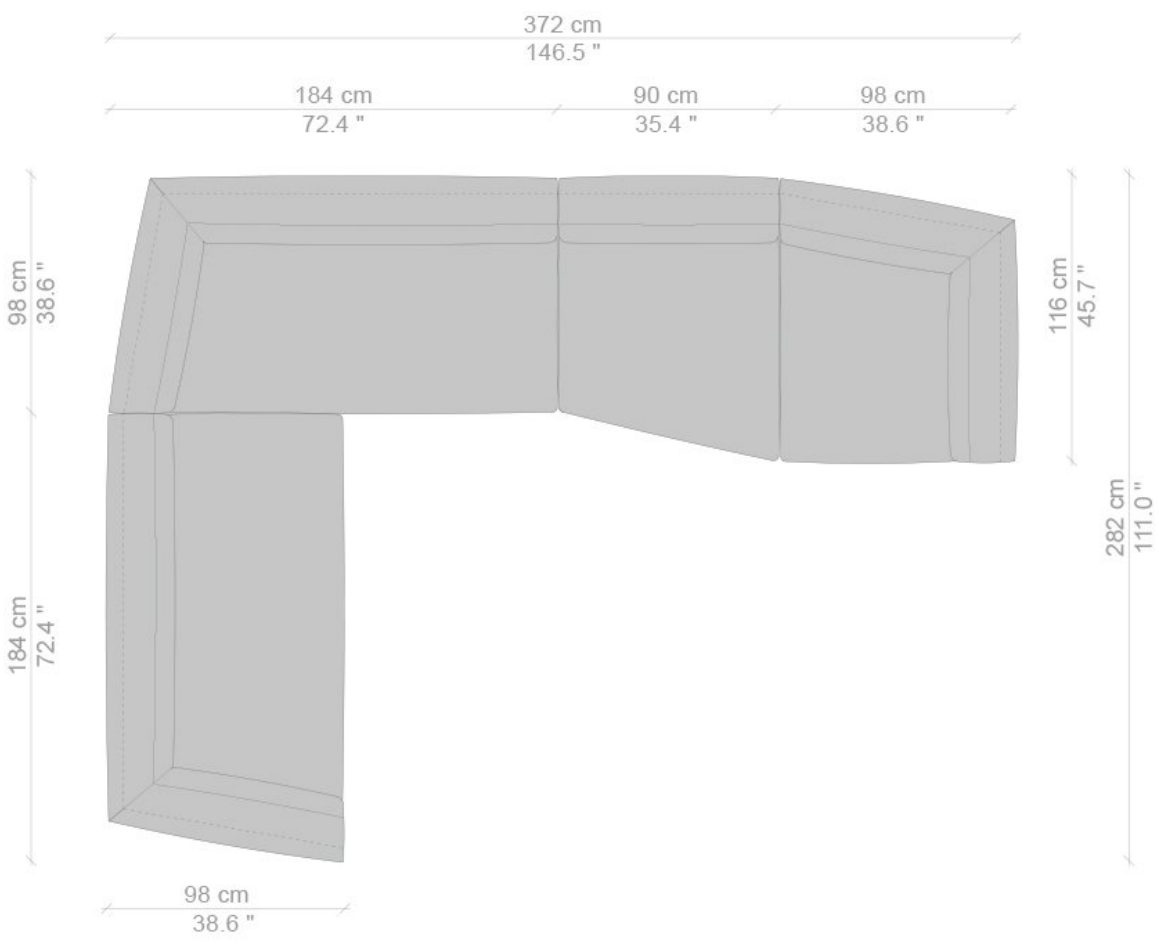

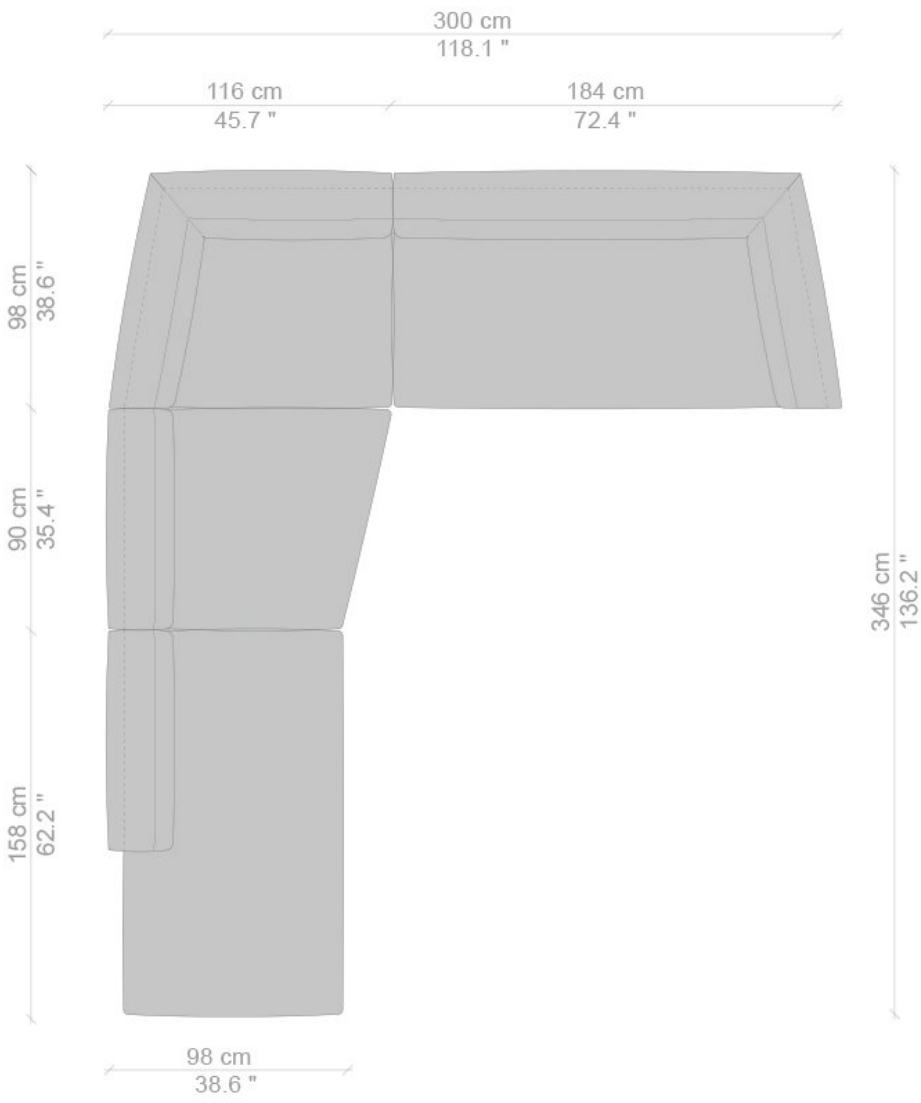

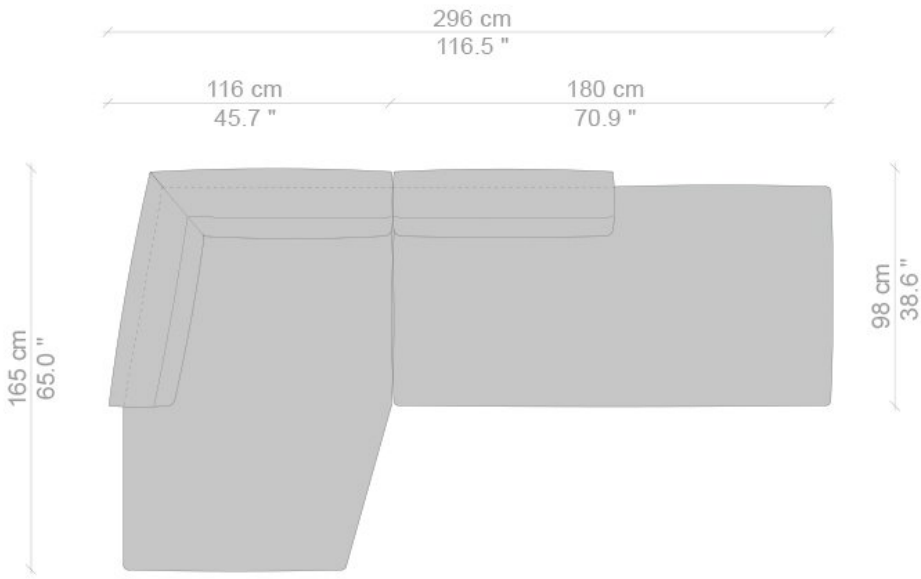
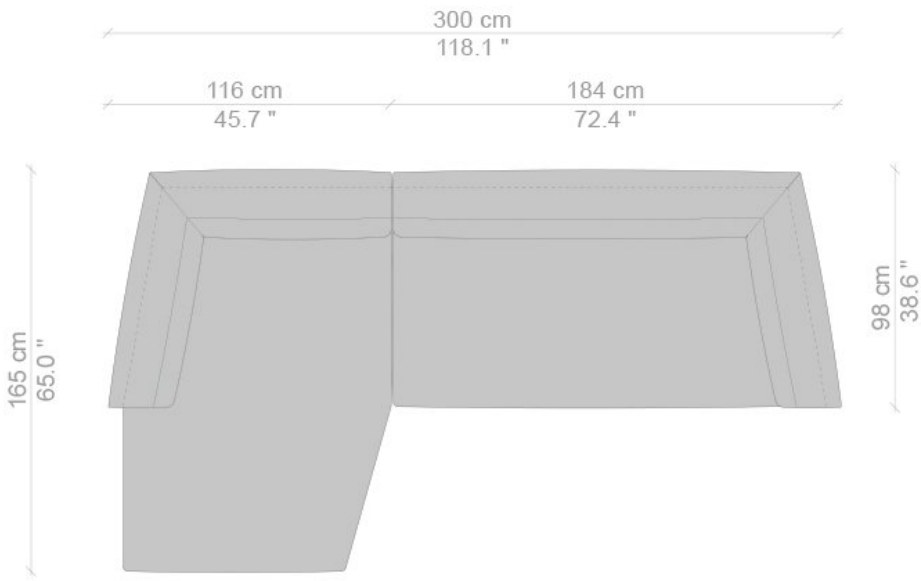

Designer



Rodolfo Dordoni

Nato nel 1954, membro di quella tradizione milanese che ha prodotto nomi come Castiglioni, Zanuso, Magistretti e de Lucchi, si laurea in architettura al Politecnico di Milano nel 1979. Da allora disegna per alcune delle maggiori Aziende del settore dell'arredo e dell'illuminazione. Per alcune di queste, in qualità di responsabile del settore design, individua e coordina le strategie di prodotto. Da anni lavora come designer e consulente per Aziende di alto profilo sia nel campo del design industriale, con Artemide e Moroso, che nel campo della progettazione d'interni per negozi, showrooms e manifestazioni, con Panasonic e Dolce & Gabbana. Progetta inoltre edifici residenziali, ville, spazi industriali, ristoranti e hotel sia in Italia che all'Estero. Nel 2005 fonda con Alessandro Acerbi e Luca Zaniboni lo studio Dordoni Architetti, che si dedica in maniera specifica alla progettazione architettonica e all'interior design.