

The Infinito bookcase, designed in 1956/7 by Franco Albini, has expanded to include a new fixed to the wall version with a different and more stable floor support.

This model was developed - in constant collaboration with the Maestro's heirs - taking as its main reference a project designed by Albini himself together with Franca Helg in 1958, now on show at the Albini Foundation headquarters, together with drawings made for its reissue by the company Poggi. Infinito Wall is an even more contemporary and functional bookcase: thanks to the insertion of a low upright it is possible to add a dedicated storage unit with doors to create a compartment above that can hold a TV screen up to 65" with a 165cm shelf above it. The new cupboard can be equipped for the passage of cables, maintaining visual order and lightness; the doors are also available in smoked glass for the bookcase in stained black ash.

With the introduction of these new modules, the hinges have also been updated to allow door adjustment and cushioned closure.

Gallery



Dimensions

165 cm
65.0 "



5 cm
2.0 "

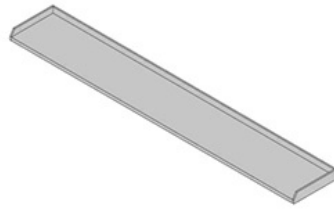

25 cm
9.8 "



50 cm
19.6 "



80 cm
31.5 "

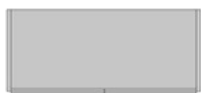
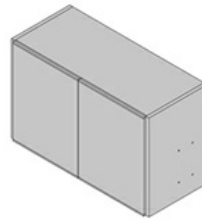

35 cm
13.7 "

12 cm
4.7 "

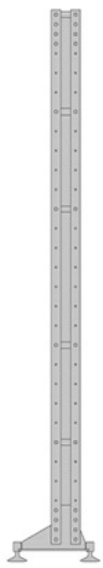

227 cm
89.4 "

5 cm
2.0 "



38 cm
15.0 "

12 cm
4.7 "

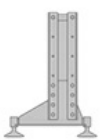

51 cm
20.1 "

5 cm
2.0 "

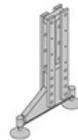

38 cm
15.0 "

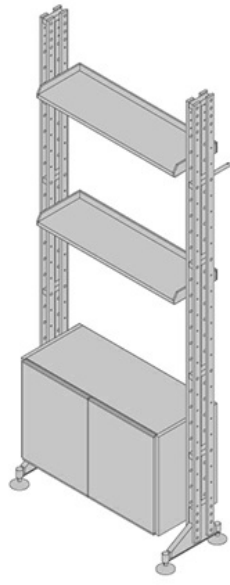
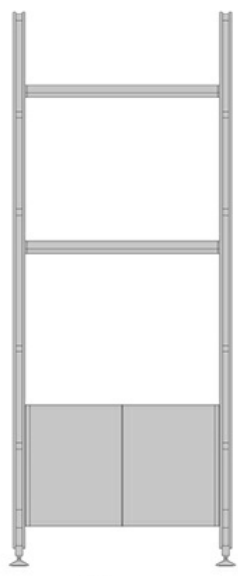
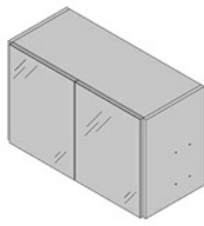
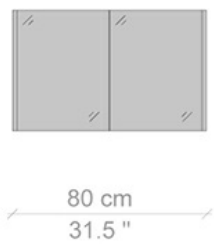

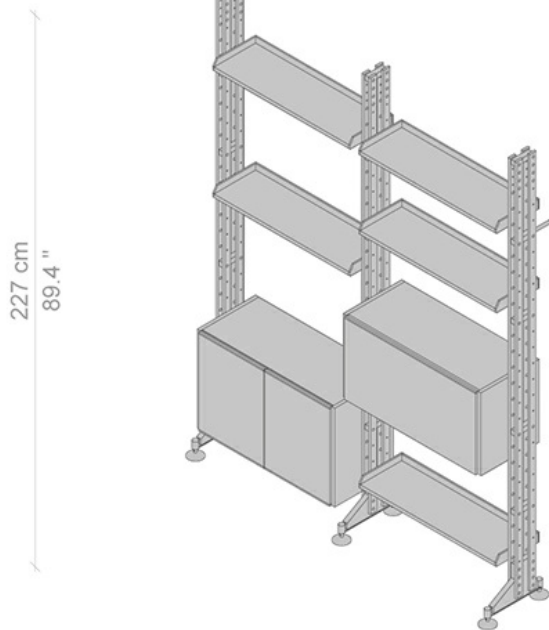
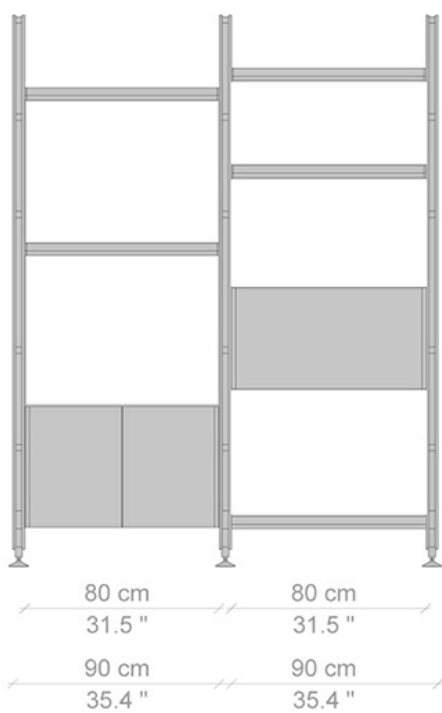
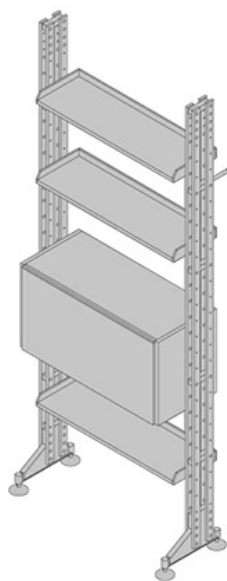
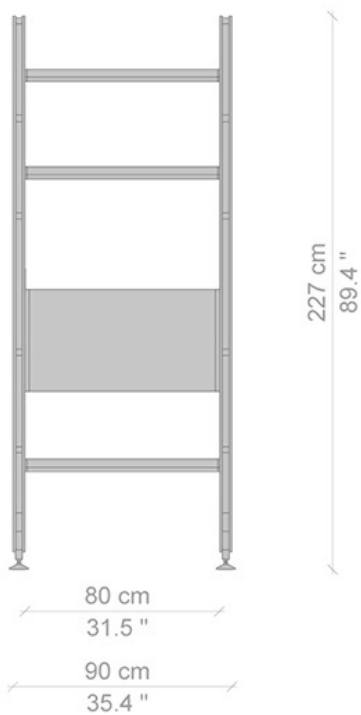

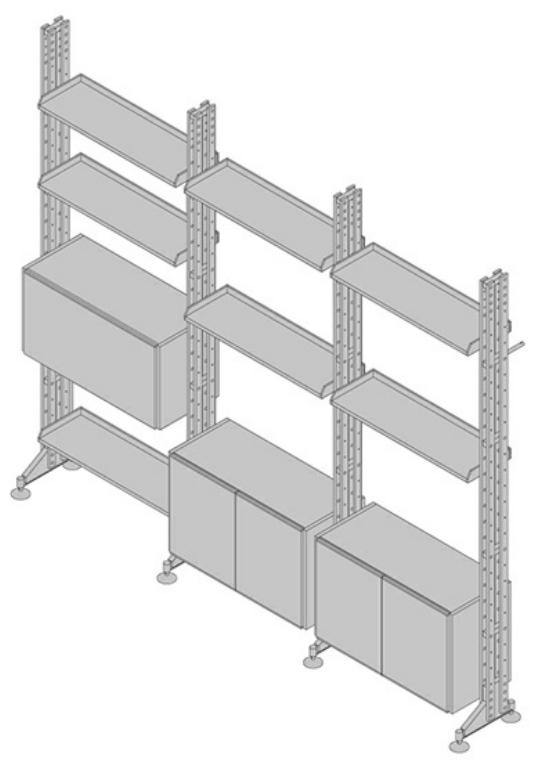
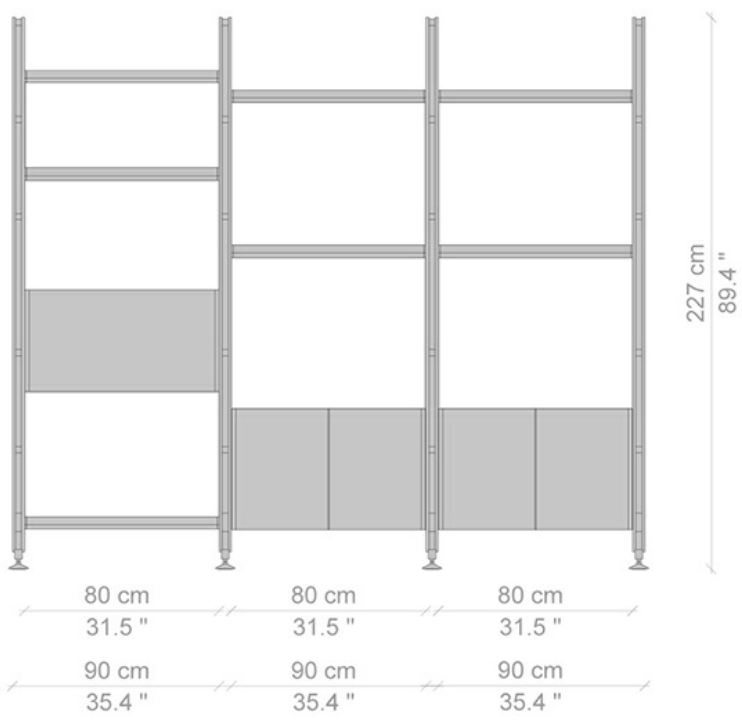
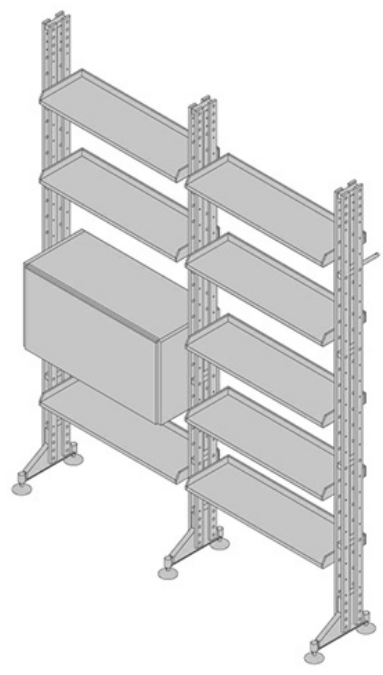
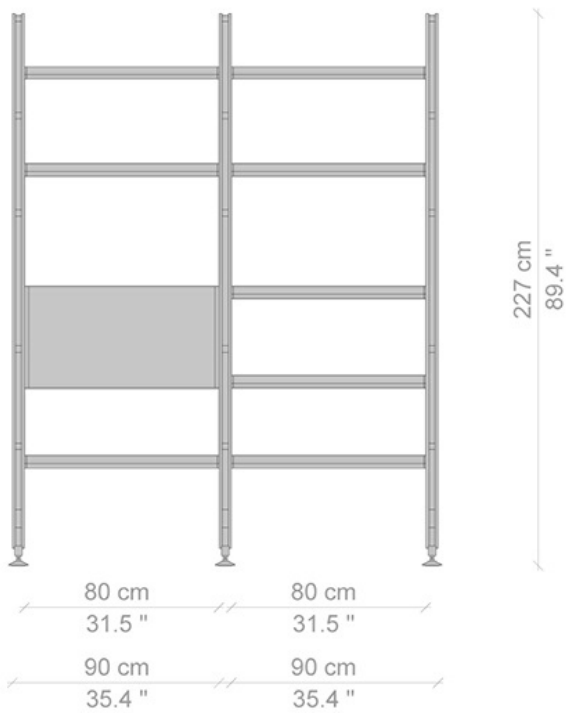

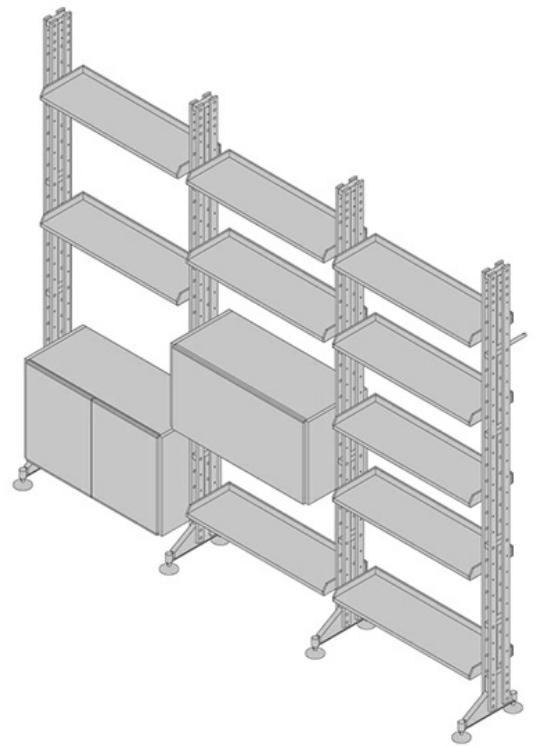
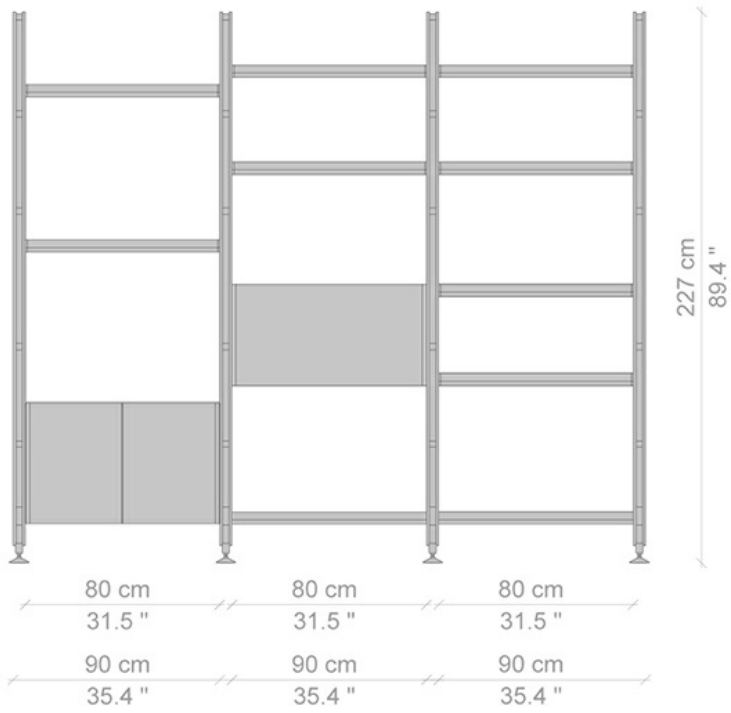

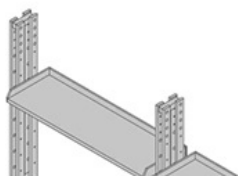
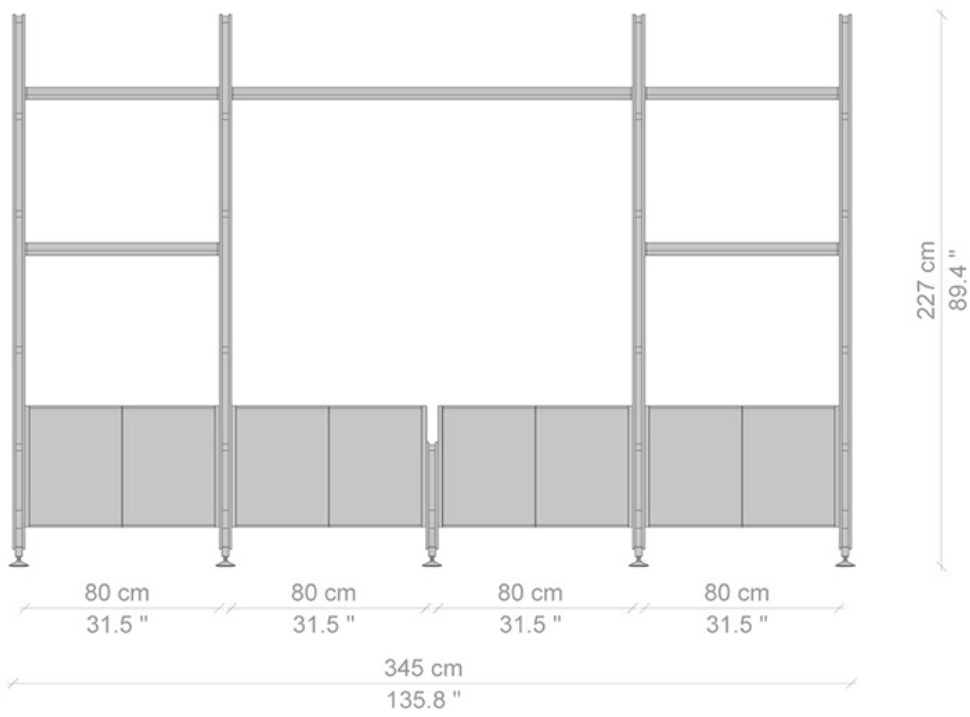

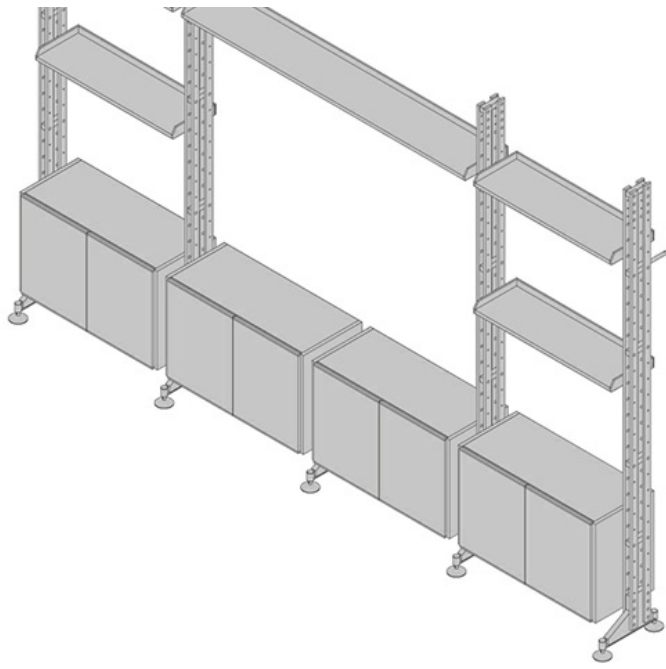

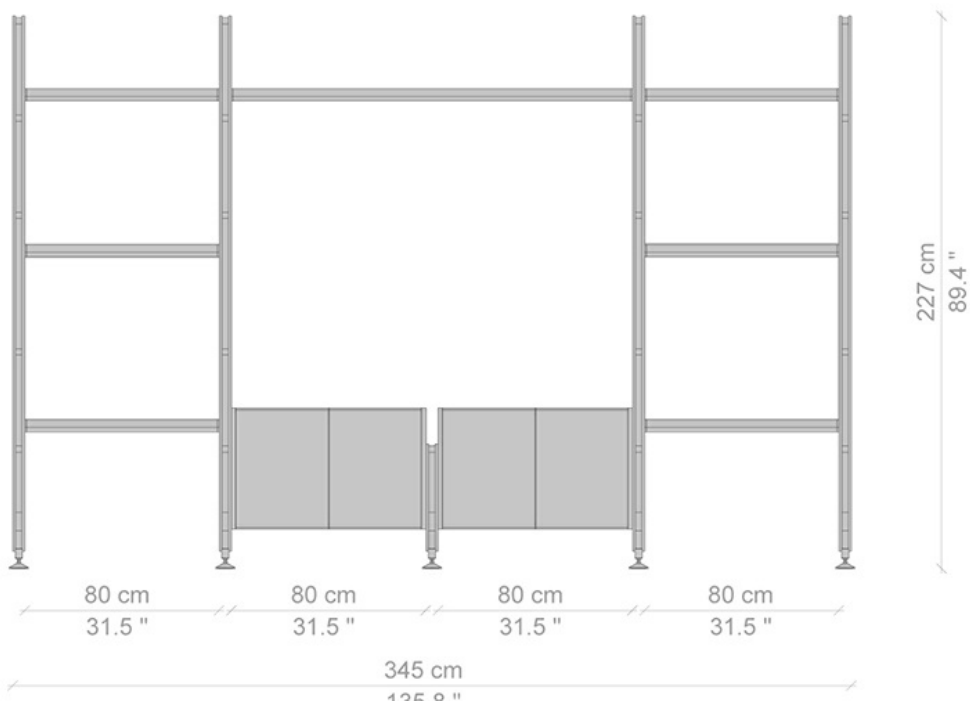

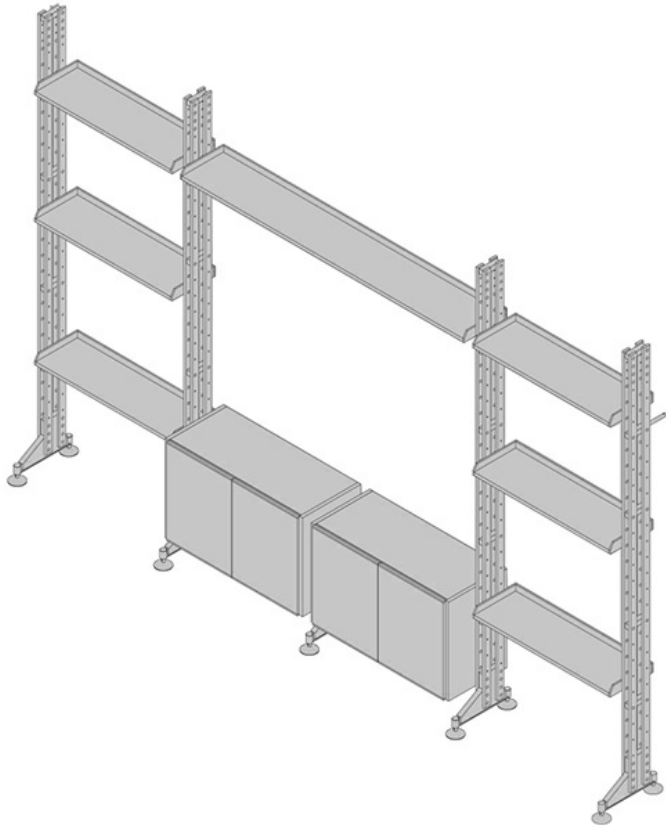

Designer

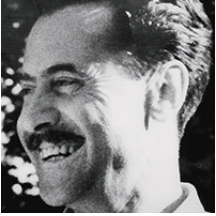

Franco Albini

He was a major figure in the Rationalist Movement, excelling in architectural, furniture, industrial and museum design.

After receiving a degree in architecture from the Politecnico di Milano in 1929, he worked with the Ponti and Lancia design studios. His work for the magazine Casabella also played a key part in his development, marking his conversion to the Rationalist Movement and his becoming its spokesman on the Italian cultural scene.

When he set up his own practice in Milan in 1931, he took on the challenge of workers' housing and continued in this vein after the war, thanks to the opportunities offered by the reconstruction projects he worked on with Franca Helg from 1952.

During the 1940's, Albini expanded his collaboration with Cassina, which started with chair designs that paved the way for his signature style. He also pursued his furniture designs with other firms, such as Poggi.

Milan and Genoa form the geographical axis where Albini left his strongest imprint. For the Lombard capital, he planned the development of the stations on Line 1 of the city's subway system (1962/63), in collaboration with graphic designer Bob Noorda. His numerous urban development and building projects for Genoa include the Palazzo Bianco (1949/51), Palazzo Rosso (1952/62), and Tesoro di San Lorenzo (1952/56) museums.

Franco Albini was the recipient of many honors in recognition of the importance of his cultural contributions.

Among others, he is a member of the INU, the CIAM, the Accademia Ligustica di Genova, MOMA in New York, the ADI, the Accademico di S. Luca, the Fondazione Pagano and the London Royal Society of Arts.

He also received numerous prizes, including the La Rinascente-Compasso d'Oro for the design of the Luisa chair (1955), the Bronze Medal from the Parson School in New York (1956) for his contribution to industrial design, the Olivetti Award for Architecture (1957), the Gran Premio Nazionale La Rinascente-Compasso d'Oro (1958), the La Rinascente-Compasso d'Oro Award for the Milan Line 1 Subway project (1964), and the Royal Designer for Industry title awarded by the London Royal Society of Arts (1971).

In all his work, from home furnishings to industrial and museum design projects, Franco Albini always instilled a logical consistency, an extreme purity of expression and exceptional ethical and historical integrity.

The architectural and design work of Franco Albini represents a keystone of the Italian architectonic culture from the early 20th century through his intense activity revolving around a creative and rigorous approach to composition and building that expresses a particularly high degree of aestheticism.

<http://www.fondazionefrancoalbin.com>