

Sofas, armchair and ottoman. Rectangular back cushions or square removable feather cushions. The upholstery completely covers the frame leaving visible the polished aluminium feet. Padding in different densities CFCfree polyurethane foam. Upholstery in fabric or leather. The armrests and seats only are quilted finished.

Gallery

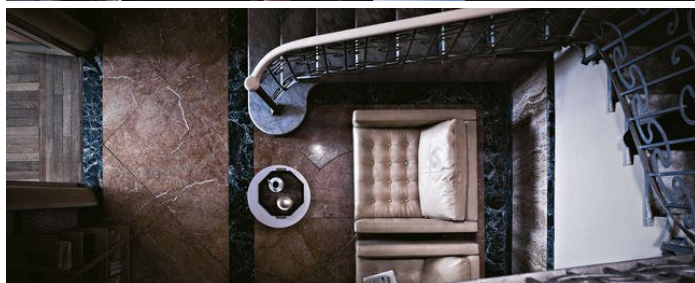

Dimensions

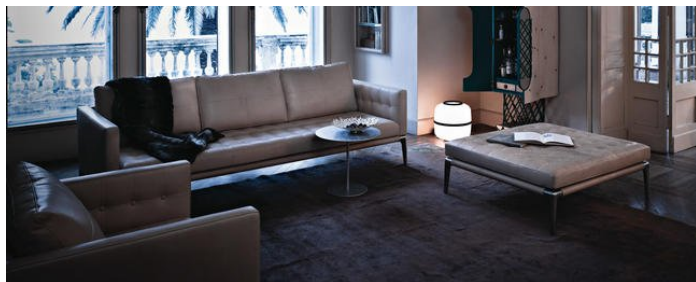
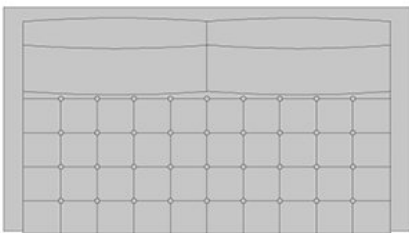
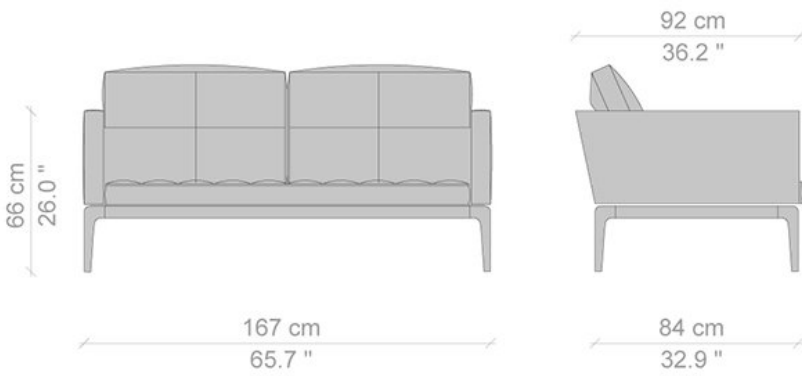
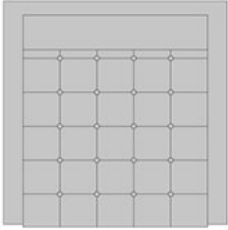
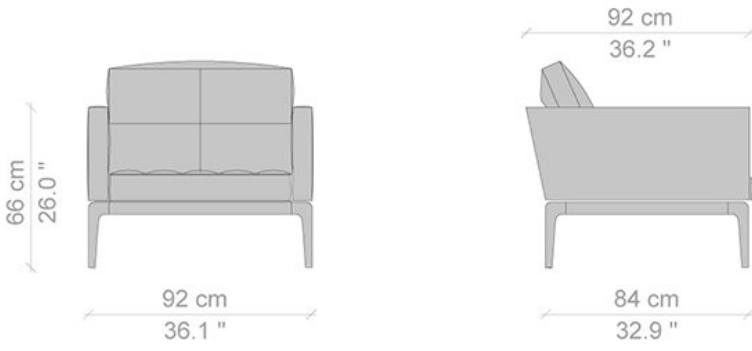

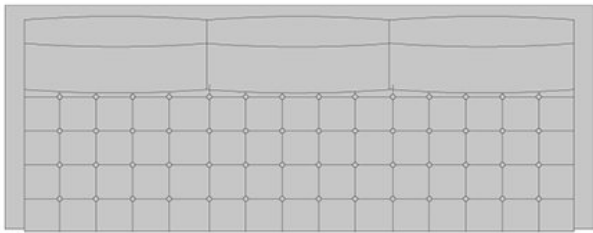
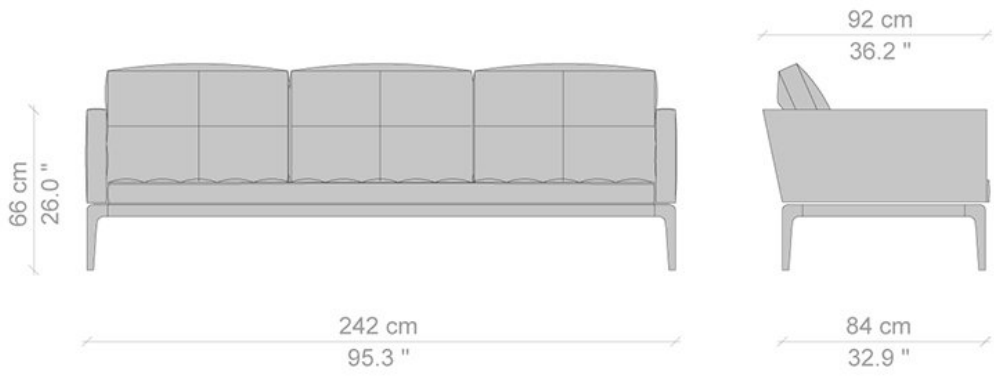

41 cm
16.1"



103 cm
40.5"



110 cm
43.3"

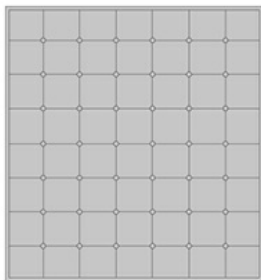

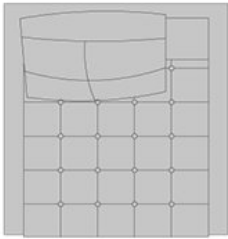
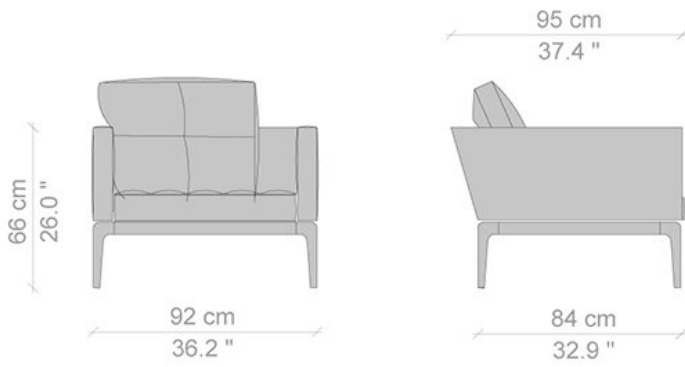

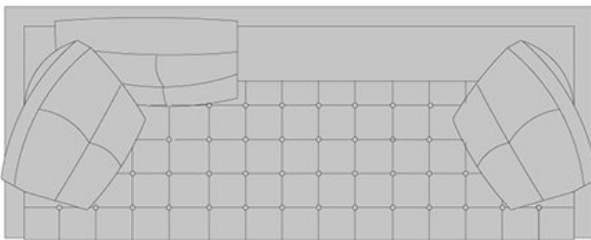
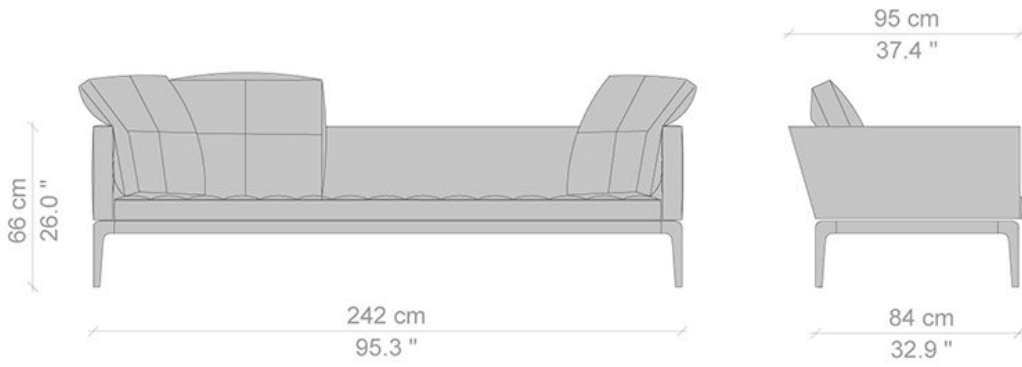
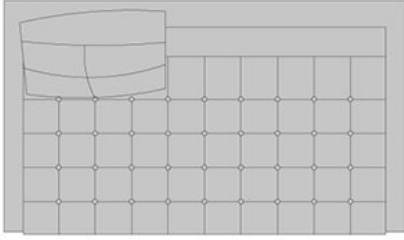
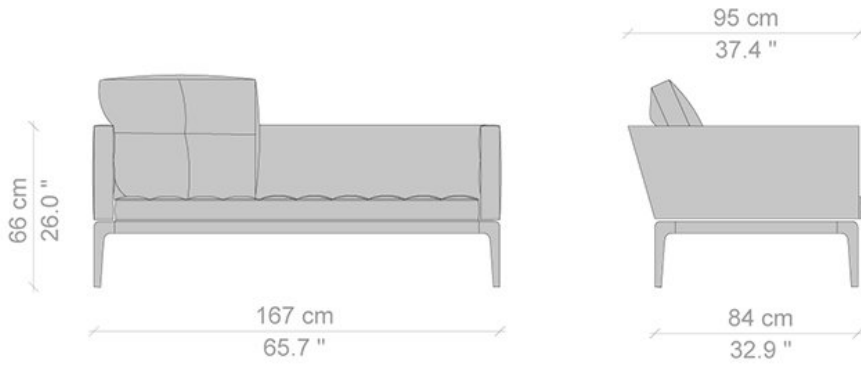

Designer



Philippe Starck

"Subversive, ethical, ecological, political, fun: this is how I see my duty as a creator." Philippe Starck. Despite his thousands of projects - completed or in the making - his global fame and his tireless protean inventiveness, never forget the essential. Philippe Starck has a mission and a vision: creation, whatever shape it takes, must make life better for the largest number of people possible. Starck believes this highly poetic, political, rebellious, benevolent, pragmatic and subversive duty must be borne by all and he resumes it with the humour that has accompanied his approach since the earliest days: "No one is forced to be a genius, but everyone has to take part."

His anticipatory concern for environmental implications, his profound comprehension of contemporary mutations, his enthusiasm for imagining new lifestyles, his determination to change the world, his devotion to a positive reduction, his love of ideas, his desire to defend the intelligence of usefulness - and the usefulness of intelligence - have accompanied one iconic creation after the other... From everyday products such as furniture and lemon squeezers, to revolutionary mega-yachts, micro wind turbines, electric cars, and hotels that aspire to be wondrous, stimulating and intensely vibrant places, Starck never ceases to push the boundaries and criteria of contemporary design. His technological miracles are vectors of democratic ecology, focused on action and a respect for the future of both humans and nature. Predicting the phenomena of convergence and dematerialisation, Philippe Starck has always devised objects that demand the most from the least. The solutions provided by his dreams are so vital, so essential that he was the first Frenchman to be invited to the legendary TED (Technology, Entertainment & Design) conferences, talks that bring together such illustrious speakers as Bill Clinton and Richard Branson. Inventor, creator, architect, designer, artistic director...

Philippe Starck is all of the above, but above all he is a man of honesty, in the purest tradition of the Renaissance artists.