

Il sistema di sedute si compone di tre divani utilizzabili singolarmente e di elementi imbottiti componibili: terminali a due o a tre posti con bracciolo sinistro o destro, intermedi a due posti, elementi angolari e chaise longue sinistri o destri, pouf e tavolini intermedi o terminali. Ciascun elemento è sorretto da un basamento a "trave": geometrico, rigoroso, di forte caratterizzazione estetica, il basamento è il cuore funzionale del sistema; consente infatti di creare varie configurazioni, aggregando gli elementi imbottiti o di comporre interessanti alternanze fra sedute, tavolini e pouf. Un'interpretazione contemporanea che pone l'accento su particolari di funzionalità e di comfort, uniti a un'attenzione per i dettagli, che ne esaltano le caratteristiche estetiche; cuscini morbidi ed accoglienti, pur senza eccedere nei volumi, lo schienale alto, il dettaglio della cucitura lungo il profilo perimetrale, l'oggetto laterale dello schienale e il bracciolo che si sovrappongono, il movimento in due posizioni del bracciolo per un buon grado di relax. Struttura: tubolare di acciaio. Imbottitura: poliuretano espanso privo di CFC, a densità differenziata. Basamento: alluminio anodizzato nero. Piedini: materiale plastico trasparente. Rivestimento amovibile in tessuto o pelle. Finiture Tavolini: noce canaletto, rovere naturale, rovere tinto nero, pietracemento.

Gallery

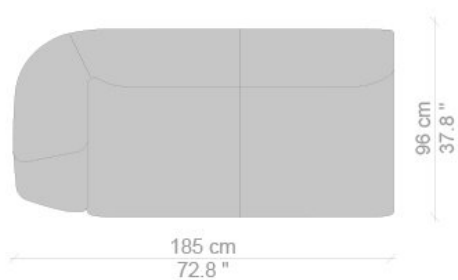

Dimensioni

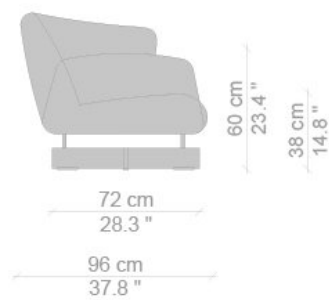
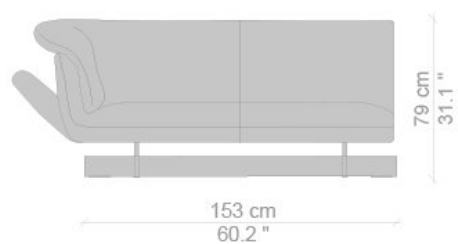
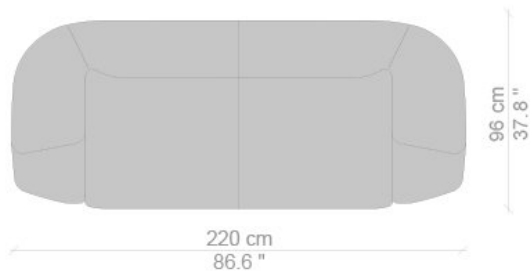
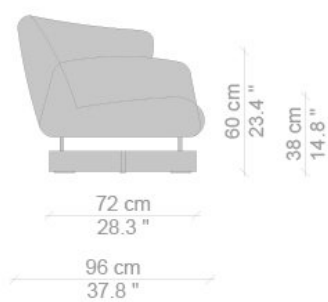
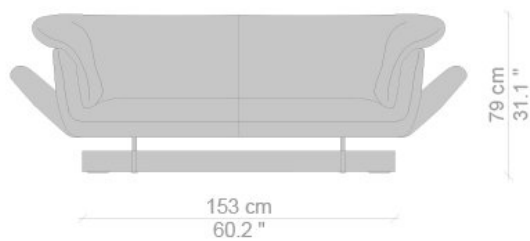

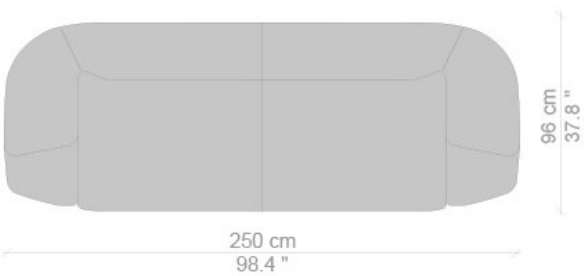
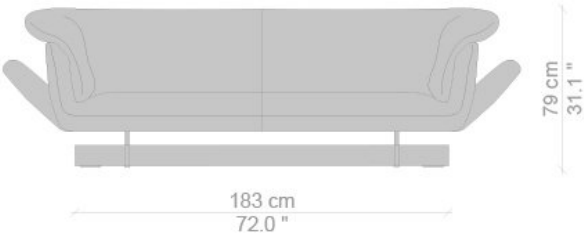
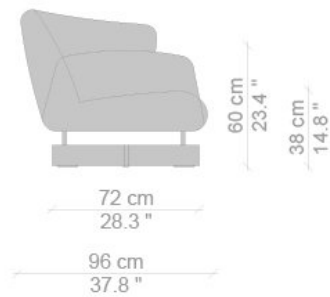
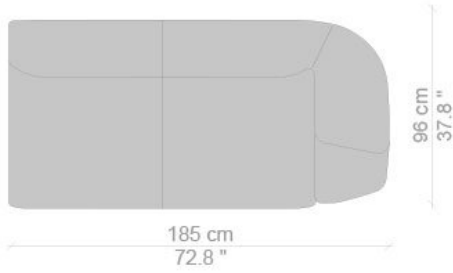
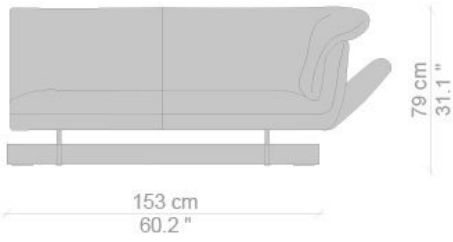

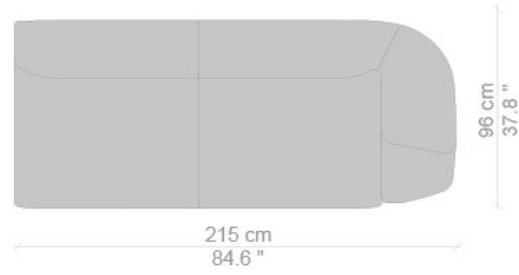
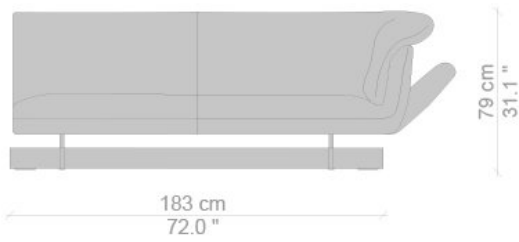
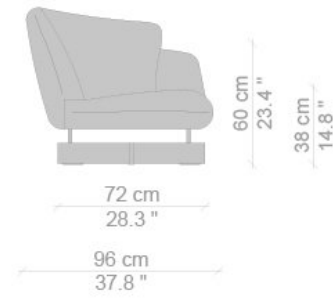
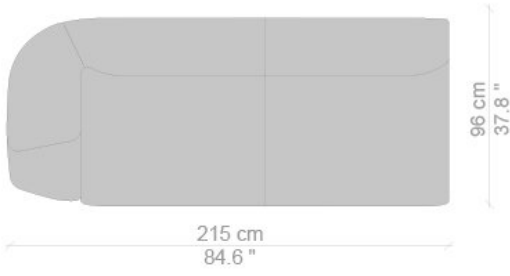
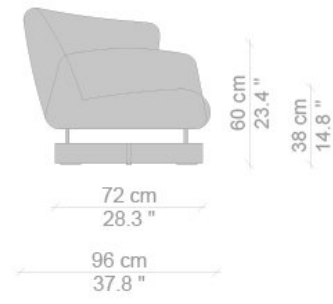
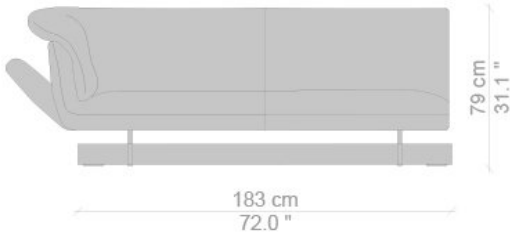

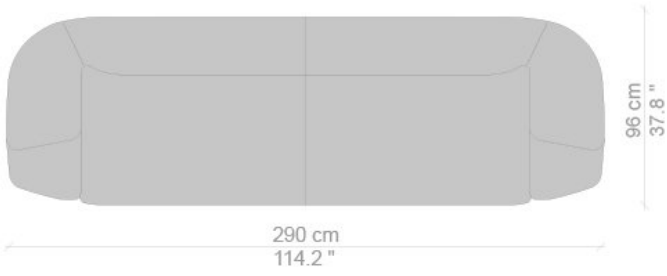
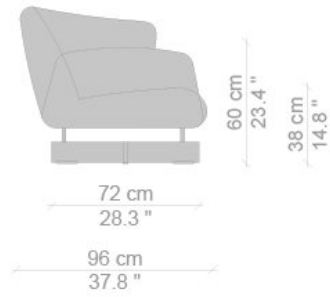
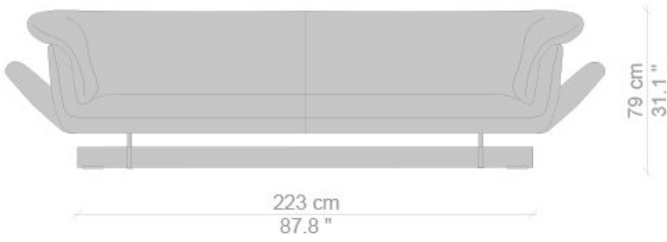

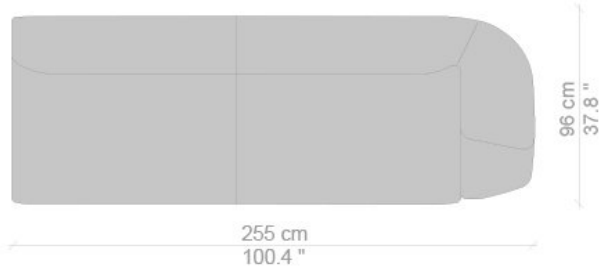
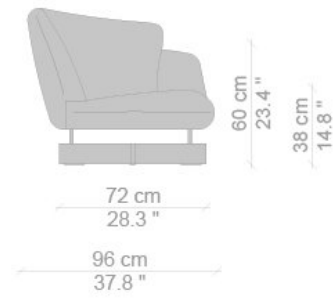
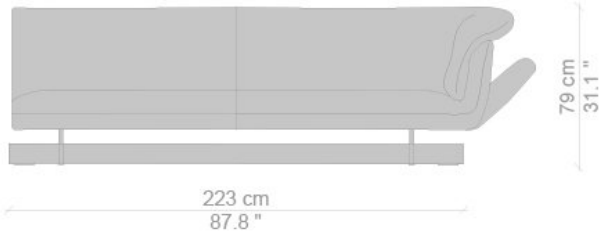
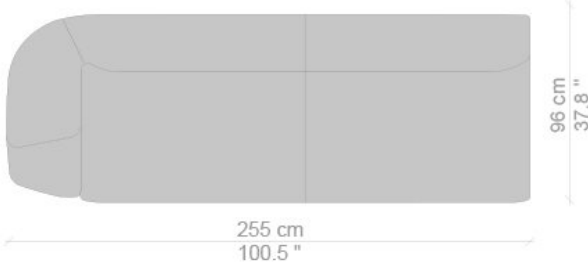
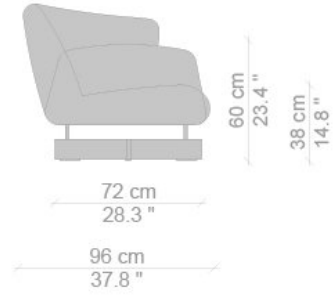

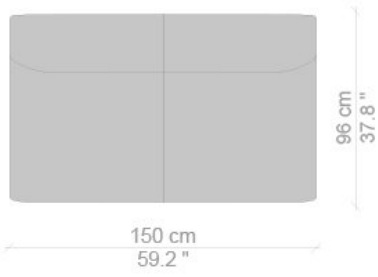
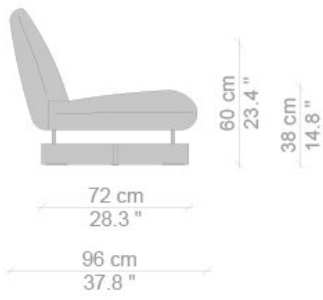
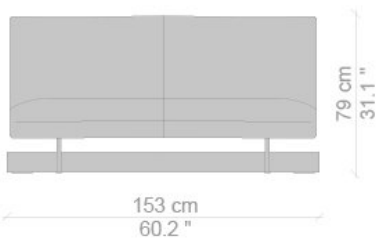

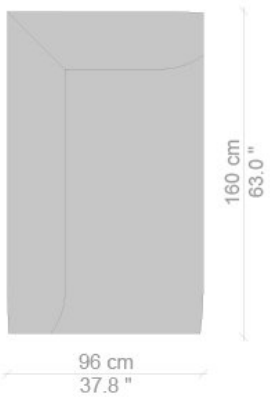
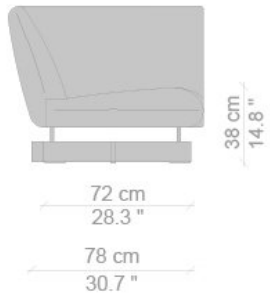
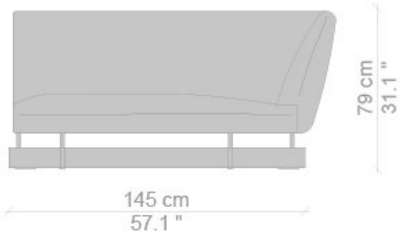

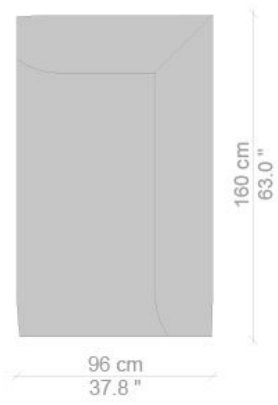
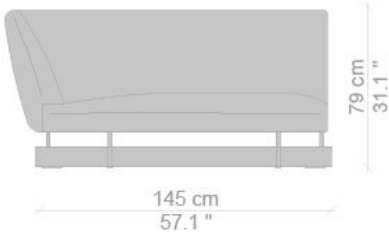

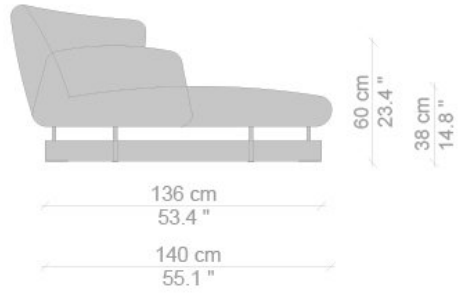
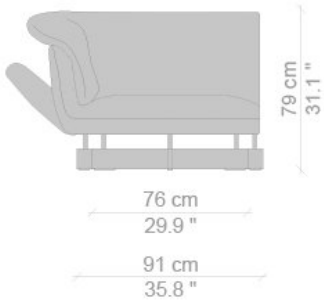

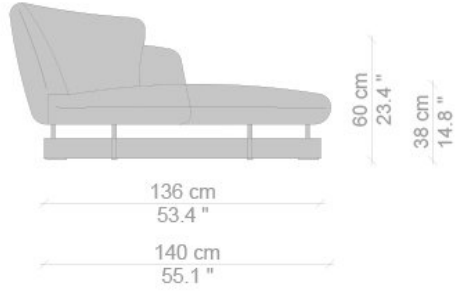

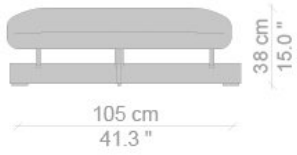
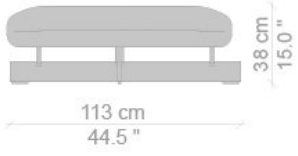



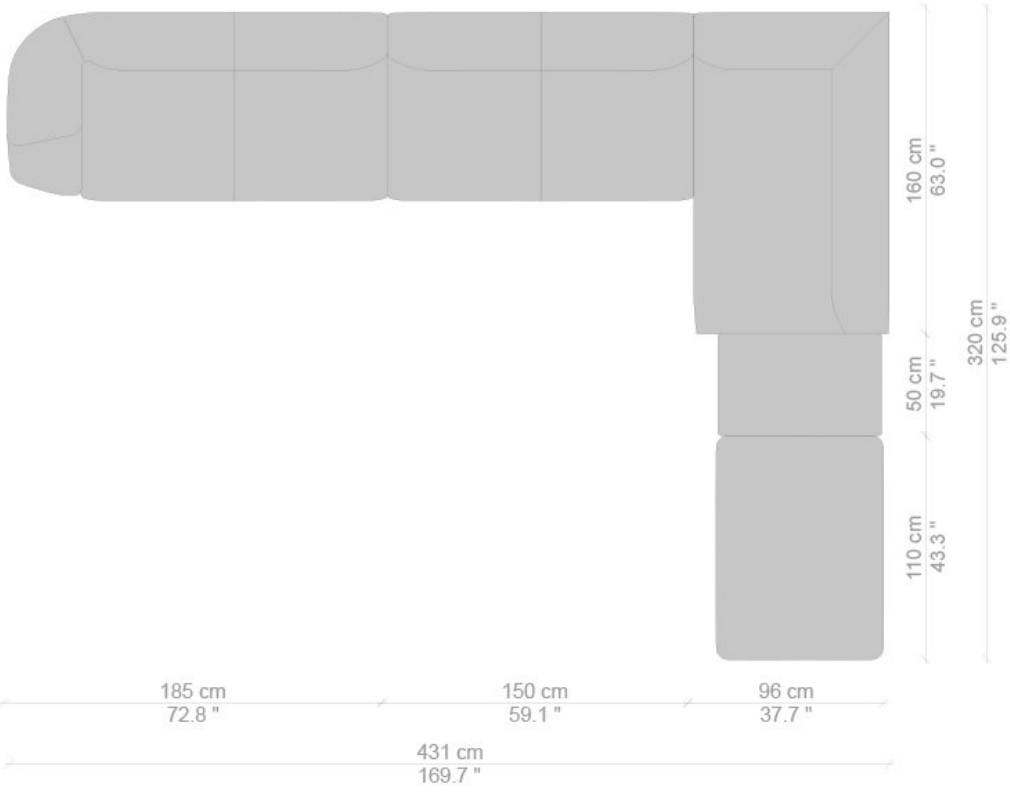

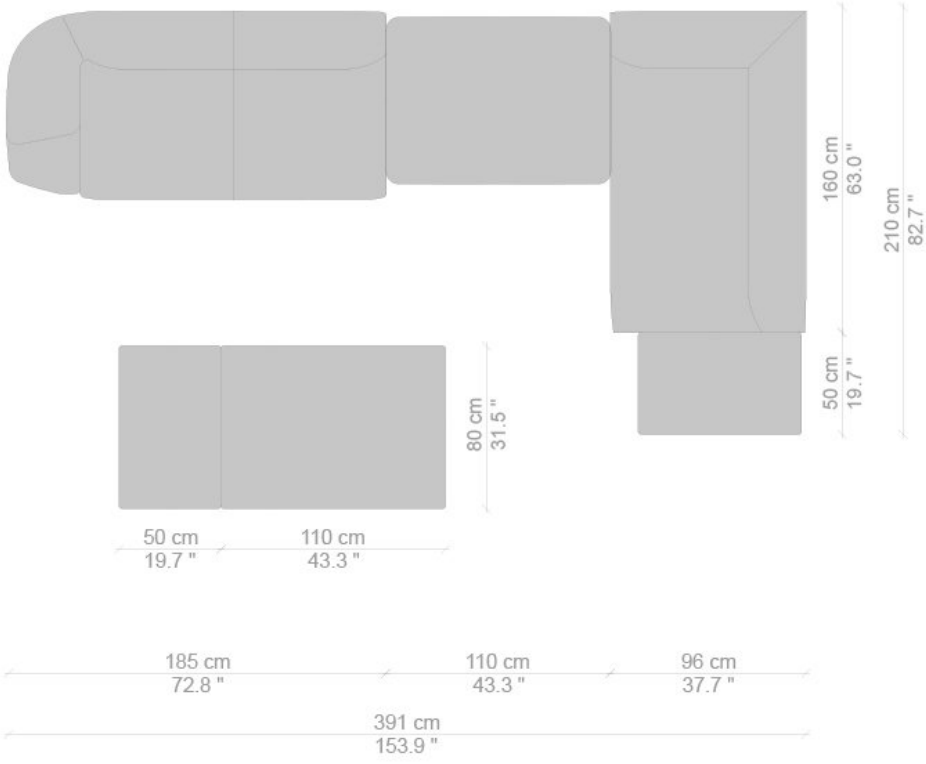
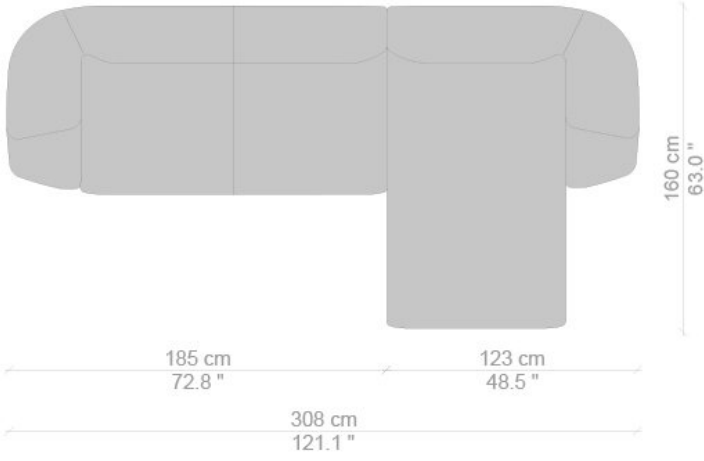

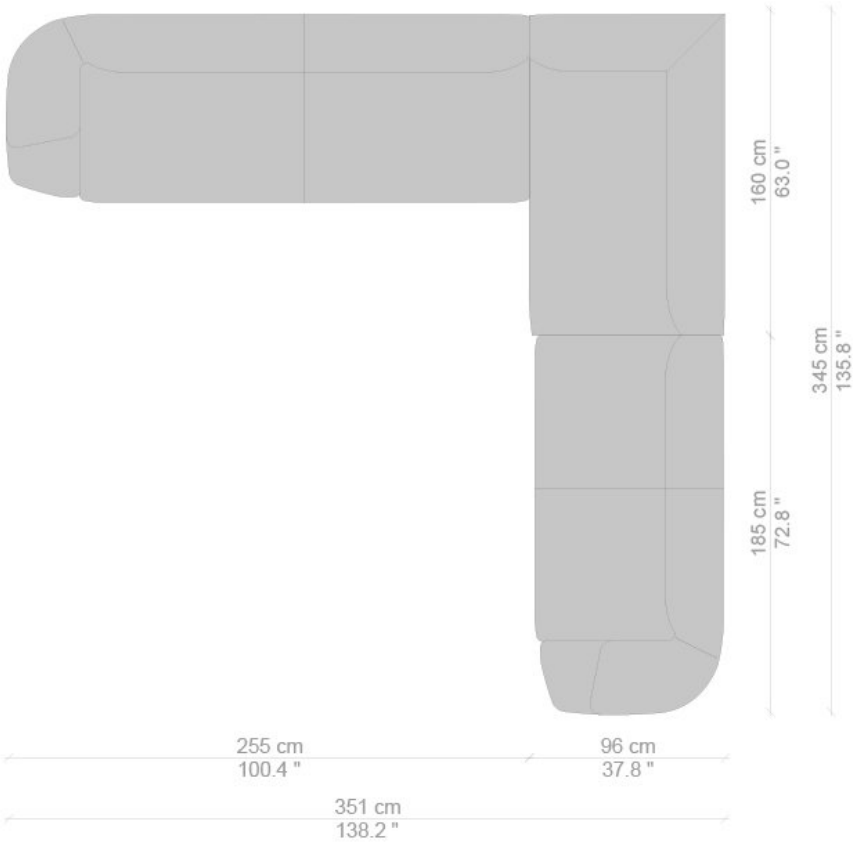
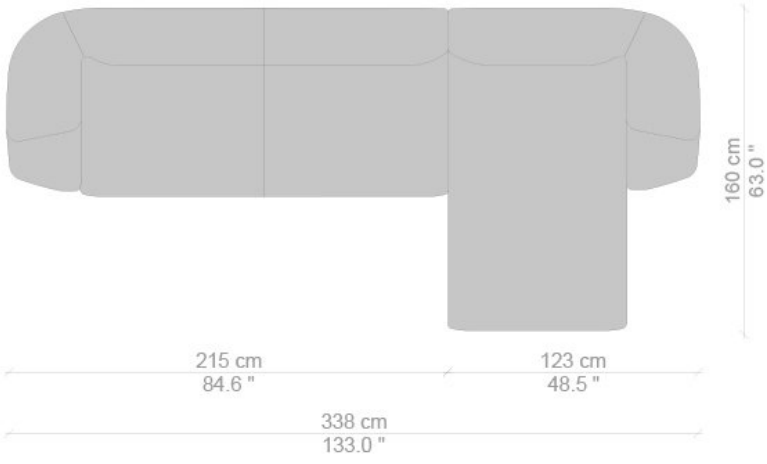

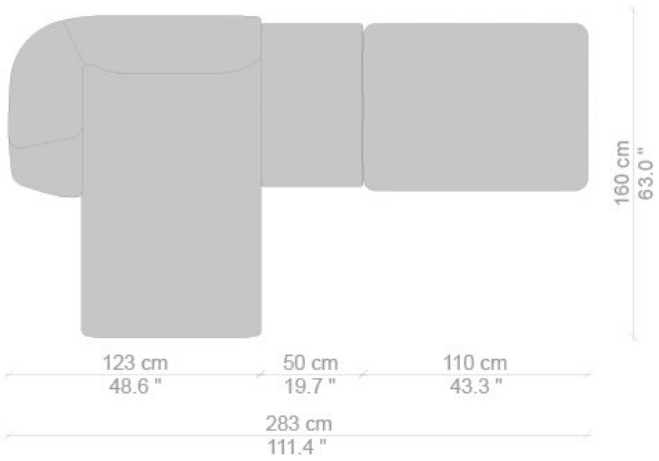
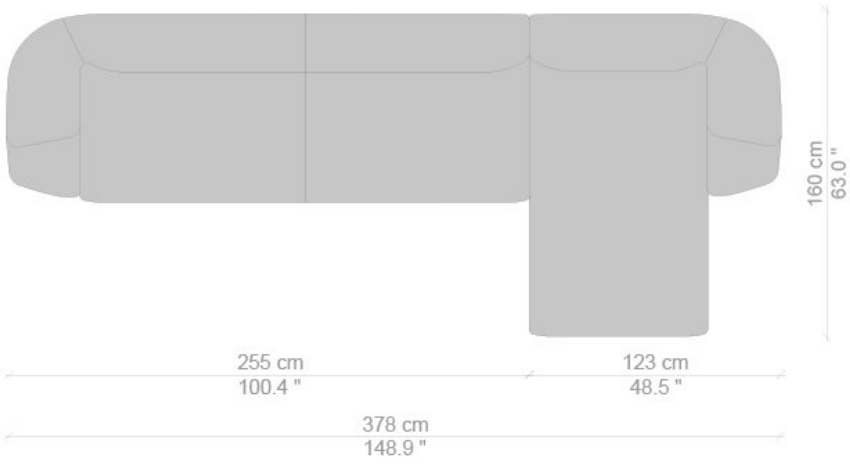

Designer



Patricia Urquiola

Patricia Urquiola è nata a Oviedo (Spagna). Vive e lavora a Milano. Ha studiato Architettura al Politecnico di Madrid e al Politecnico di Milano, dove si è laureata nel 1989 con Achille Castiglioni. È stata assistant lecturer per Achille Castiglioni; ha collaborato con Vico Magistretti; è stata responsabile Design per Lissoni Associati.

Nel 2001 apre il proprio studio lavorando nei settori del product design, interni e architettura. Tra i suoi progetti più recenti in architettura: Il museo del Gioiello di Vicenza, l'Hotel Mandarin Oriental di Barcellona, l'Hotel Das Stue a Berlino, la Spa dell'Hotel Four Seasons di Milano; progetti retail e allestimenti per Gianvito Rossi, BMW, Cassina, Ferragamo, Flos, Missoni, Molteni, Officine Panerai, H&M, Santoni, Pitti Uomo Firenze. Ha realizzato prodotti per le più importanti società italiane e internazionali, tra cui: Agape, Alessi, Axor-Hansgrohe, B&B Italia, Baccarat, Boffi, Budri, De Padova, Triade, Flos, Gan, Georg Jensen, Glas Italia, Haworth, Kartell, Kettal, Kvadrat, Listone Giordano, Louis Vuitton, Molteni, Moroso, Mutina, Rosenthal e Verywood.

Alcuni dei suoi prodotti sono esposti nei maggiori musei di arte e design, tra cui il MoMa di New York, il Les Arts decoratifs di Parigi, il Museo di Design di Zurigo, il Vitra Design Museum di Basilea, il Victorian&Albert Museum di Londra, lo Stedelijk di Amsterdam e il Museo della Triennale di Milano.

Ha vinto diversi premi internazionali tra cui: la Medalla de Oro al Mérito en las Bellas Artes del Governo Spagnolo; l'Ordine di Isabella la Cattolica, consegnato da Sua Maestà il Re di Spagna Juan Carlos I, "Designer del decennio" per le riviste Home e Häuser, "Designer dell'anno" per le riviste Wallpaper, AD Spagna, Elle Decor International e Architektur und Wohnen. E' Ambassador di Expo Milano 2015. Settembre 2015 Patricia Urquiola nominata Art Director di Cassina.