

Un projet 'haute couture' raffiné, caractérisé par d'élégants détails qui rappellent la haute couture. Une attention particulière a été portée aux coutures autour du dossier/accoudoir pour créer une pince raffinée, d'où part une fermeture éclair jusqu'à la base du canapé, tout comme pour une robe. Son apparence est encore enrichie par un profil gros grain autour des coussins d'assise, disponible en noir, blanc, gris et café au lait. Dress-Up! dispose d'un large choix d'éléments qui peuvent être combinés en de nombreuses compositions ou utilisés individuellement. Ses lignes géométriques et ses éléments asymétriques, tels que la méridienne intégrée, le rendent unique et polyvalent, tandis que le dossier/accoudoir à inclinaison ouverte souligne sa forme accueillante. Les poufs combinés, disponibles en deux mesures, ont le même détail gros grain, ainsi qu'une fermeture éclair verticale le long du côté. Pour compléter cette famille de produits pour la salle de séjour, le canapé peut être accompagné d'une série de petites tables et de coussins raffinés, toujours avec le profil gros grain.

Gallery

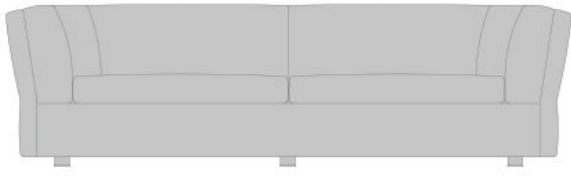



67 cm
26.4 "

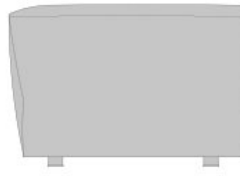

40 cm
15.7 "

230 cm
90.6 "

98 cm
38.6 "

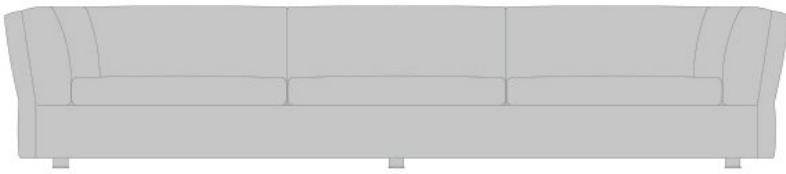

67 cm
26.4 "

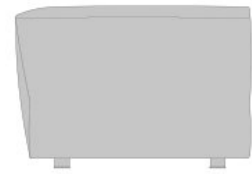

40 cm
15.7 "

320 cm
126.0 "

98 cm
38.6 "

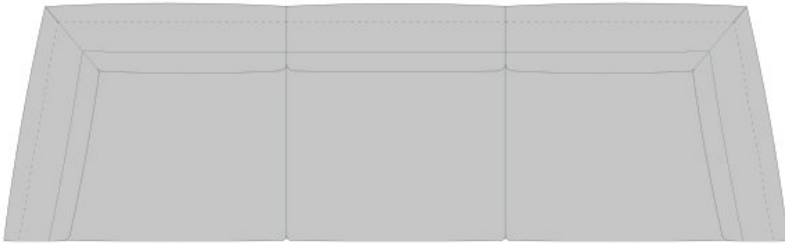



290 cm
114.2 "

67 cm
26.4 "

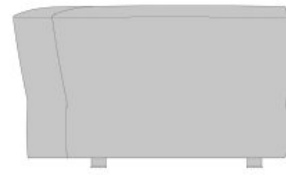

116 cm
45.7 "

40 cm
15.7 "

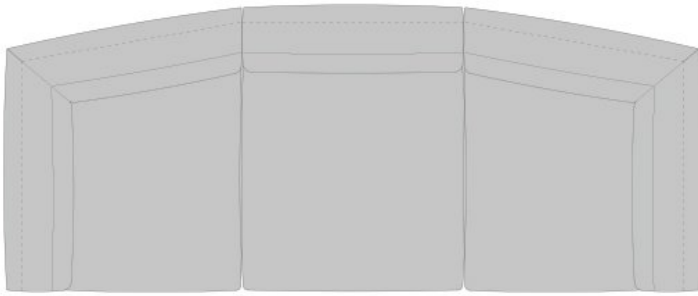

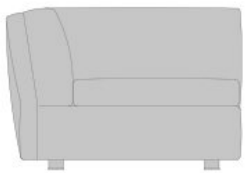

98 cm
38.6 "

67 cm
26.4 "

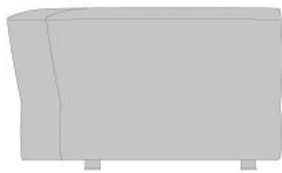

116 cm
45.7 "

40 cm
15.7 "

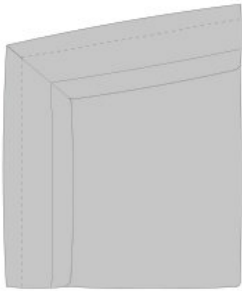

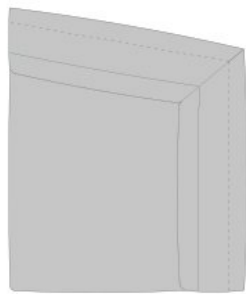
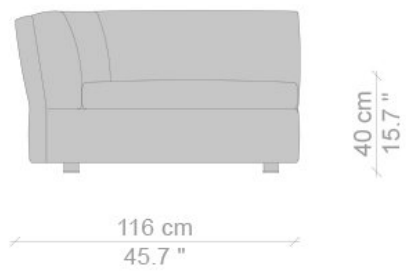

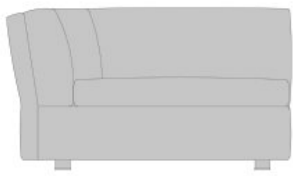

67 cm
26.4 "

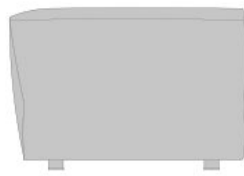

40 cm
15.7 "

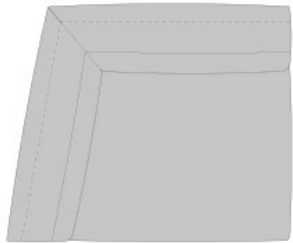

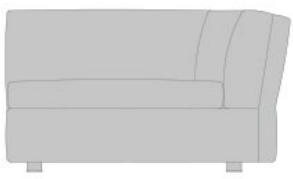

116 cm
45.7 "



67 cm
26.4 "



98 cm
38.6 "



40 cm
15.7 "

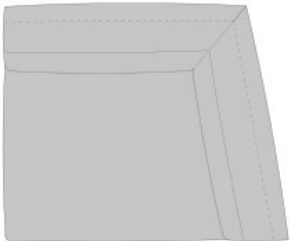



184 cm
72.4 "



98 cm
38.6 "



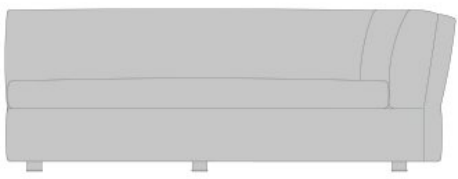

184 cm
72.4 "



98 cm
38.6 "





178 cm
70.1 "



67 cm
26.4 "

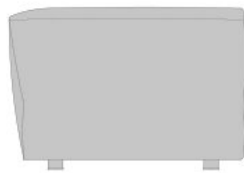

98 cm
38.6 "

40 cm
15.7 "

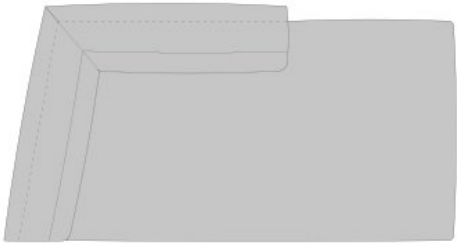



178 cm
70.1 "

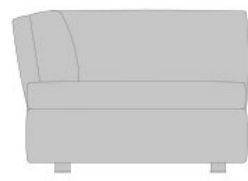

98 cm
38.6 "

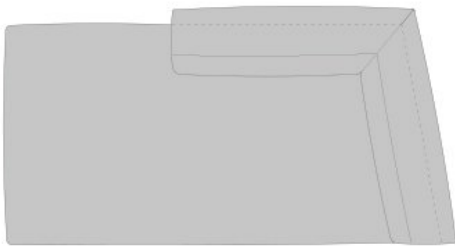

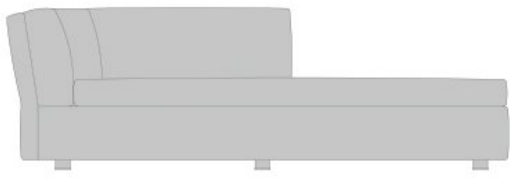

206 cm
81.1 "

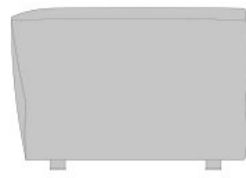

98 cm
38.6 "

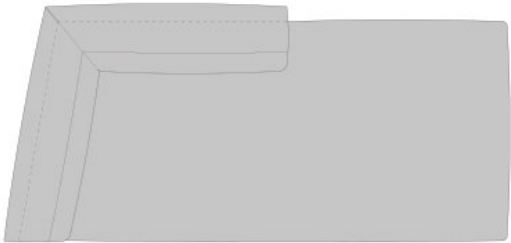



206 cm
81.1 "

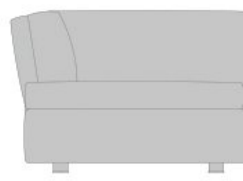

98 cm
38.6 "

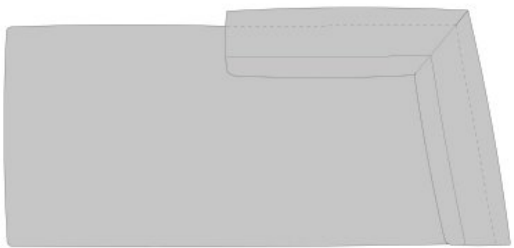

60 cm
23.6 "



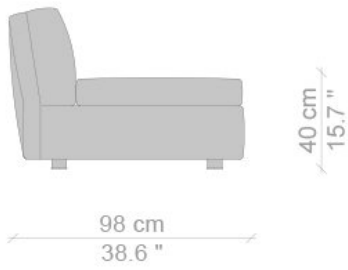
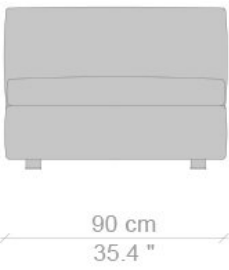
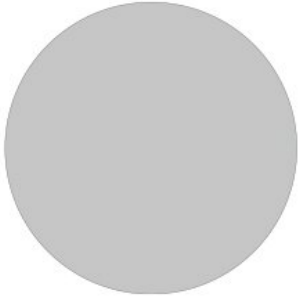
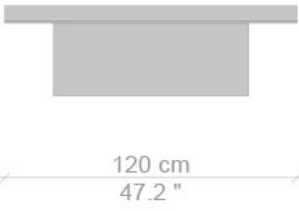



90 cm
35.4 "

67 cm
26.4 "



116 cm
45.7 "

40 cm
15.7 "

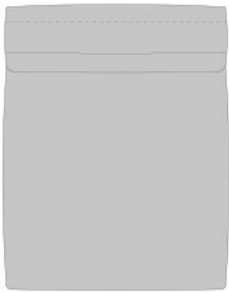



90 cm
35.4 "



67 cm
26.4 "

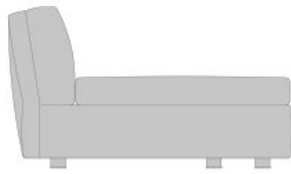

116 cm
45.7 "



40 cm
15.7 "

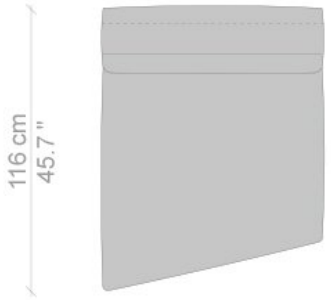

116 cm
45.7 "



90 cm
35.4 "



90 cm
35.4 "

67 cm
26.4 "

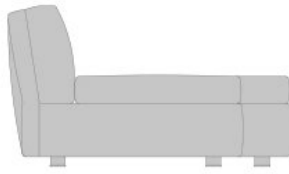

116 cm
45.7 "

40 cm
15.7 "

90 cm
35.4 "



116 cm
45.7 "



158 cm
62.2 "

67 cm
26.4 "

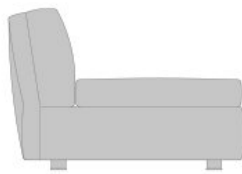

98 cm
38.6 "

40 cm
15.7 "

90 cm
35.4 "

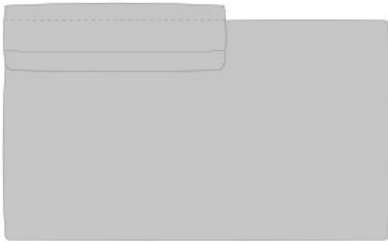

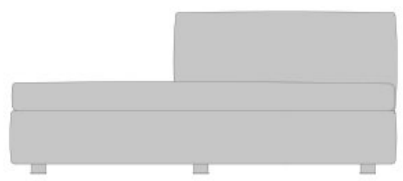

67 cm
26.4 "

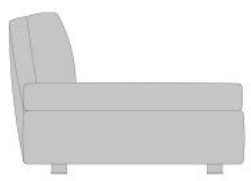

40 cm
15.7 "

158 cm
62.2 "

98 cm
38.6 "

90 cm
35.4 "

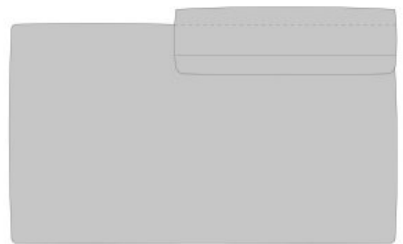



67 cm
26.4 "

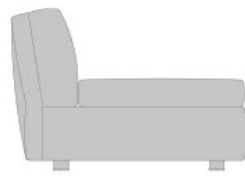

40 cm
15.7 "

180 cm
70.9 "

98 cm
38.6 "

90 cm
35.4 "

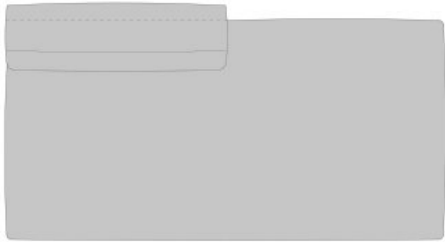



67 cm
26.4 "

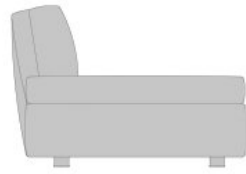

40 cm
15.7 "

180 cm
70.9 "

98 cm
38.6 "

90 cm
35.4 "

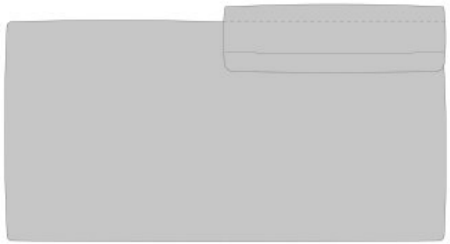

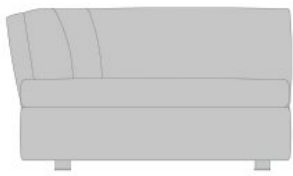

116 cm
45.7 "



67 cm
26.4 "

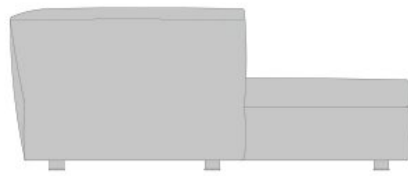

165 cm
65.0 "



40 cm
15.7 "

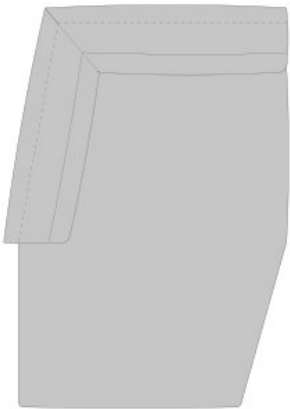

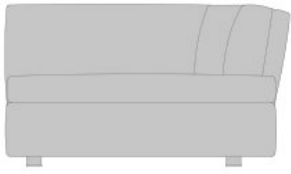

116 cm
45.7 "



67 cm
26.4 "



165 cm
65.0 "



40 cm
15.7 "

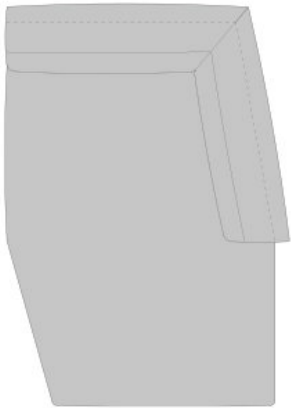

40 cm
15.7 "



45 cm
17.7 "



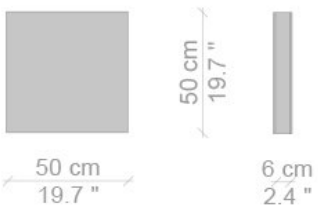
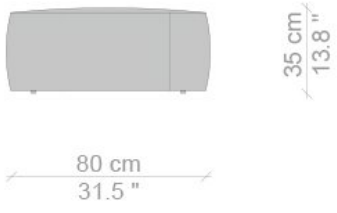

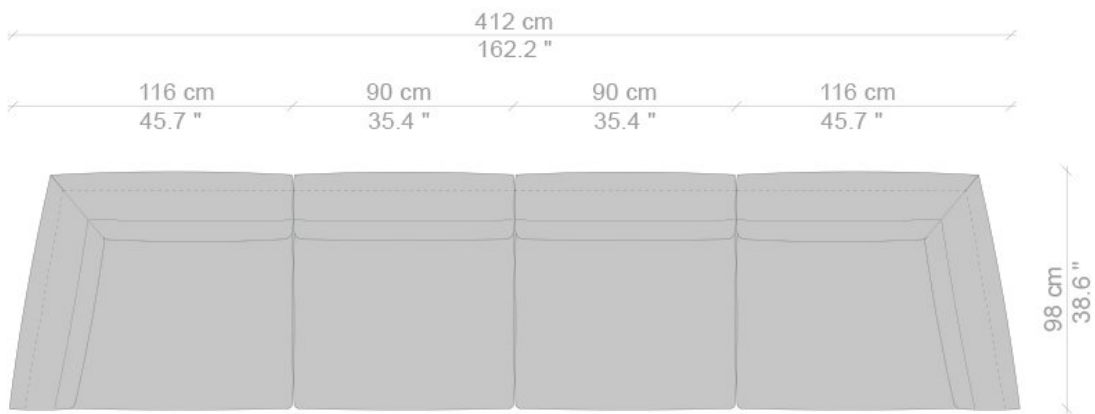
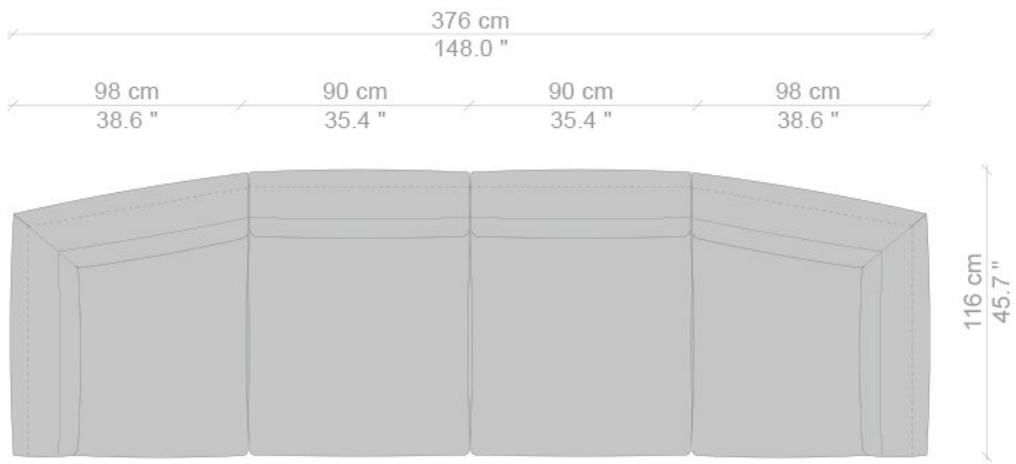

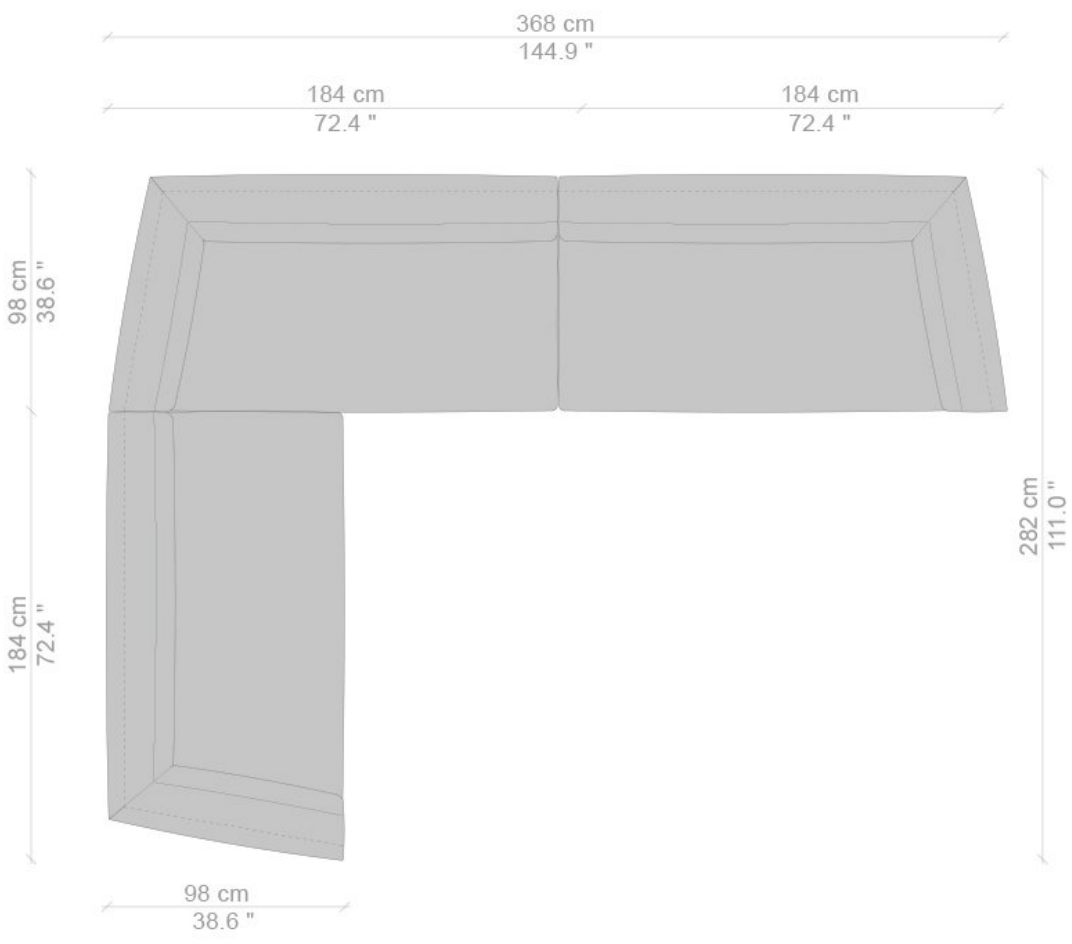
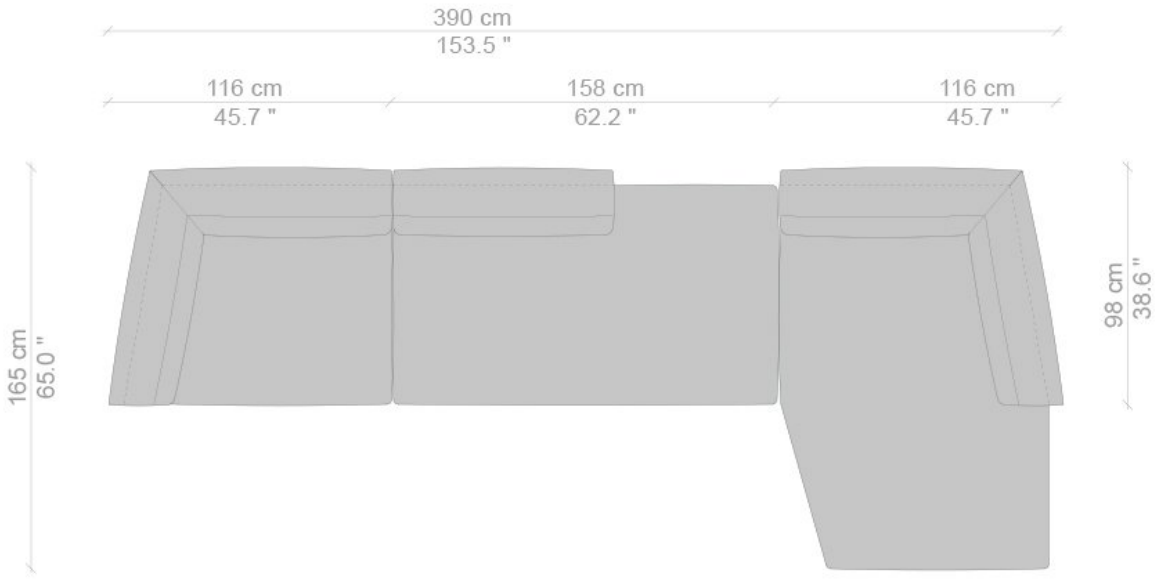

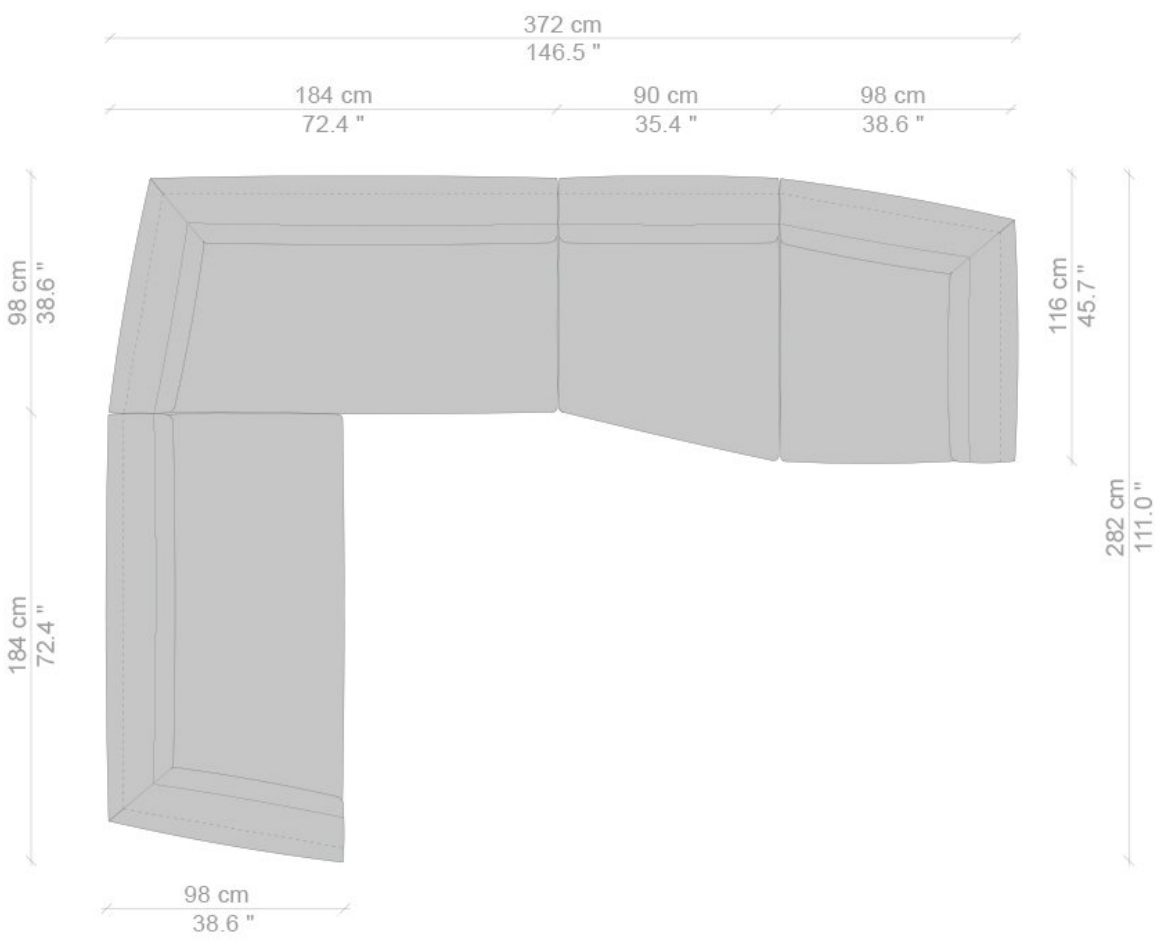

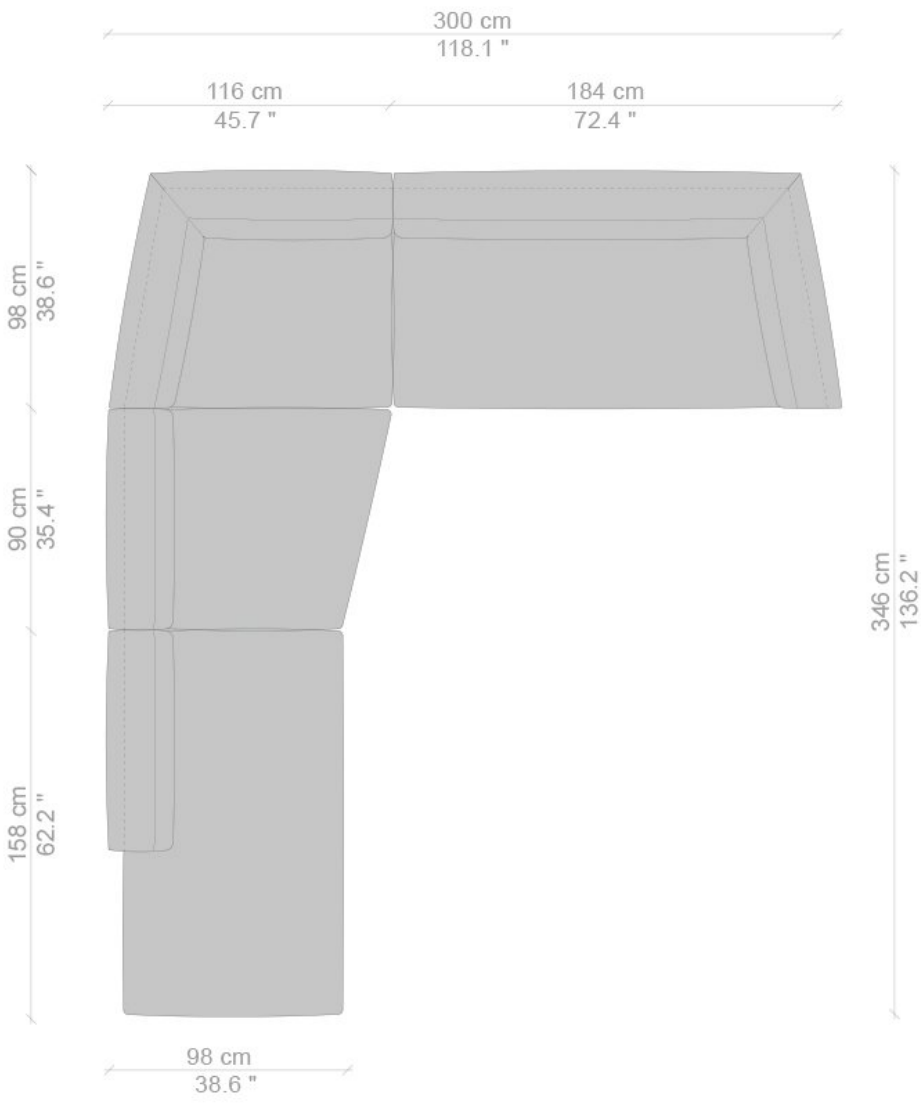

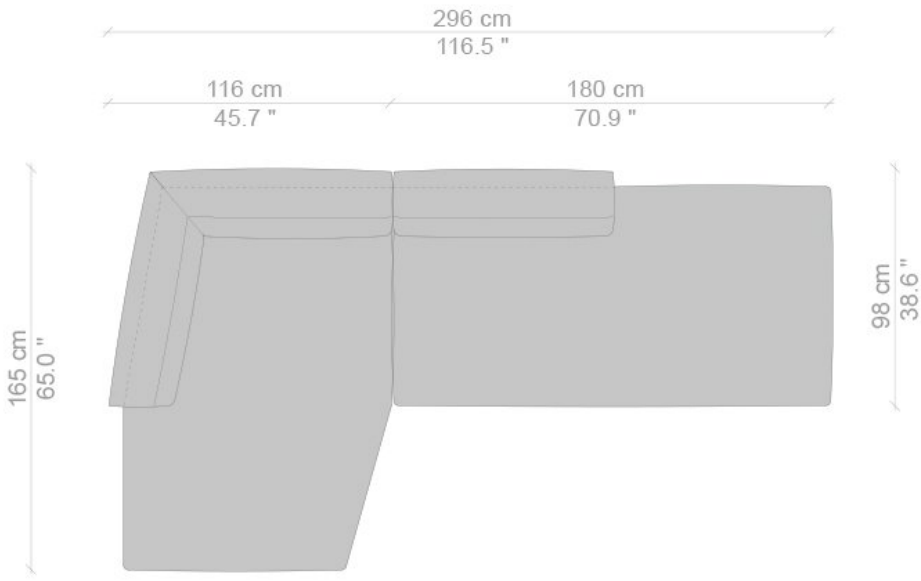
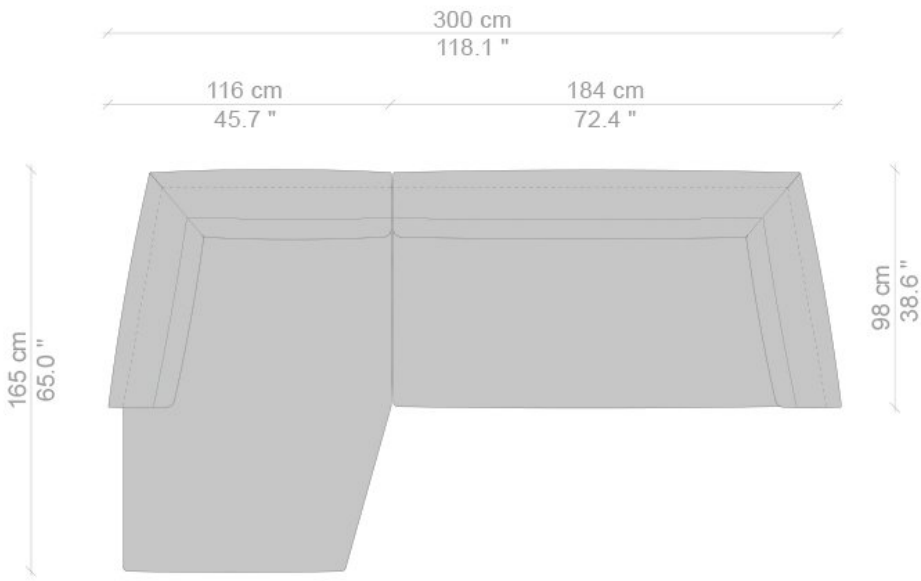

Designer



Rodolfo Dordoni

Né en 1954, membre de la tradition milanaise qui a produit des célébrités comme Castiglioni, Zanuso, Magistretti et de Lucchi, il obtient sa licence en architecture au Politecnico (Université Polytechnique) de Milan en 1979. Depuis lors il dessine pour quelques-unes des plus grandes Entreprises du secteur de l'ameublement et de l'éclairage. Pour certaines d'entre elles, en qualité de responsable du secteur design, il élabore et coordonne les stratégies de production. Il travaille depuis des années comme designer et conseiller pour des Entreprises haut de gamme, tant dans le domaine du design industriel, avec Artemide et Moroso, que dans le domaine de la conception d'intérieur pour des magasins, des salles d'exposition et des salons, avec Panasonic et Dolce & Gabbana. Il conçoit en outre des édifices résidentiels, des pavillons, des espaces industriels, des restaurants et des hôtels, tant en Italie qu'à l'étranger.

Il a fondé en 2005, avec Alessandro Acerbi et Luca Zaniboni, le cabinet Dordoni Architetti, qui se dédie de façon spécifique à la conception architecturale et à la décoration intérieure.